

Evaluating Candidates for Spinal Cord Stimulation, Spinal Surgery, and Intrathecal Pumps

A Primer and Glossary of Terms
For Psychologists

Daniel Bruns, PsyD

John Mark Disorbio, EdD

v2.1

Acknowledgements

We would like to thank Giancarlo Barolat MD of the Barolat Institute for his review of this document, and for his many helpful suggestions.

Table of Contents

ACKNOWLEDGEMENTS	2
PART I: AN OVERVIEW OF SPINAL ANATOMY, CONDITIONS AND TREATMENTS	5
Spinal Anatomy	6
Sprains and strains.....	8
Vertebral conditions	11
Spine-Related Nerve Disorders	17
Sacroiliac (SI) joint	18
Spinal surgical procedures	19
Other terms.....	23
Diagnostic procedures	25
Spinal surgery considerations	26
PART II: NEUROMODULATION AND OTHER ELECTRICAL TREATMENTS FOR PAIN	27
Neuromodulation	28
Implanted Electrical Neuromodulation Therapies.....	28
Spinal Cord Stimulation Science.....	37
Electronic Neuromodulation Concepts	45
Surface Electrical/Magnetic Neuromodulation Therapies.....	50
TRANSCRANIAL MAGNETIC STIMULATION.....	50
Electrical Therapies That Are NOT Neuromodulation.....	51
Spinal Cord Stimulation: Assessment Considerations	52
PART III: INTRATHECAL PUMPS	55
Chemical Neuromodulation Therapies.....	56

PART IV: PRESURGICAL PSYCHOLOGICAL ASSESSMENT FOR SPINAL SURGERY, SPINAL CORD STIMULATION, AND INTRATHECAL DRUG DELIVERY SYSTEMS	60
Spinal Surgery Treatments and the Biopsychosocial Model	61
Practice Models of Presurgical Psychological Assessments for Spinal Surgery for Pain	62
Spinal Surgery Psychological Assessment Concepts	66
Diagnosis and the Mind-Body Diagnostic Matrix	74
The Mind-Body Matrix.....	76
Spinal Surgery Psychological Assessment Methods	77
Caveats.....	79
Conclusions.....	79
Risk, Medical Necessity And Recommended Treatment	80
PART V: Q&A POST PRESURGICAL PSYCHOLOGICAL EVALUATION FOR SCS WEBINAR	81
Conducting the SCS Psych Eval and Forming Opinions	81
Test Comparisons	85
Risk Assessment	88
Validity Assessment and Decisions	93
Billing and Coding	98
Case Vignette.....	100
Links	101
REFERENCES	102

Part I: An Overview of Spinal Anatomy, Conditions and Treatments

Spinal Anatomy

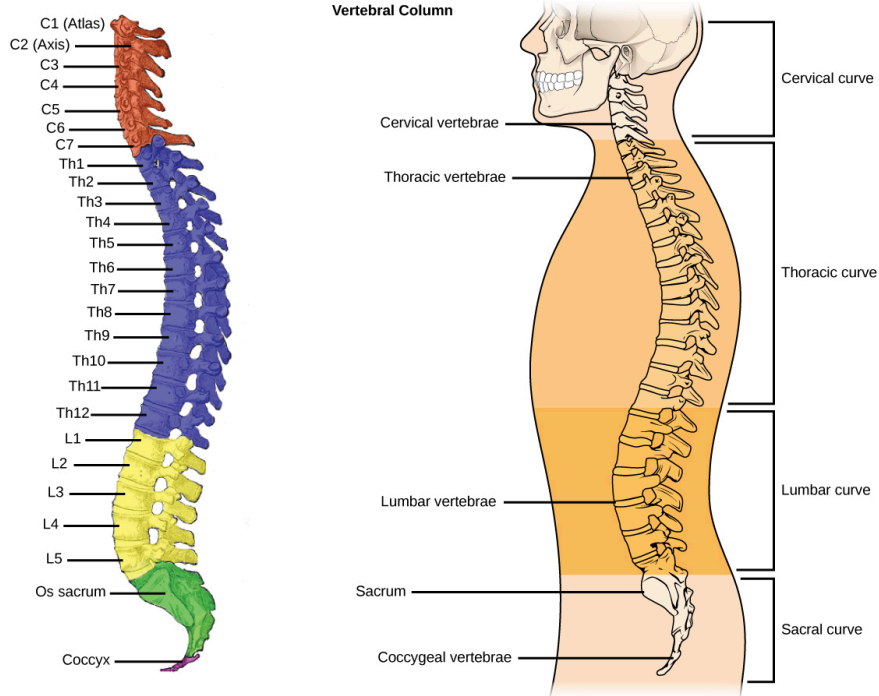

https://commons.wikimedia.org/wiki/File:Figure_38_01_07.jpg

Cervical vertebra. The seven vertebrae within the neck region of the spine, numbered C1 through C7.

Thoracic vertebra: The 12 vertebrae contained within the thoracic region of the spine, in which our attached to ribs. Thoracic vertebra are numbered from T1 to T12.

Lumbar vertebra: The five vertebrae contained within the lumbar region of the spine, which is the part below the rib cage. These vertebrae are labeled L1 through L5.

Sacrum: The portion of the spinal column appearing below the lumbar region.

Coccyx. Also called the tailbone, is the lowest segment of the vertebral column.

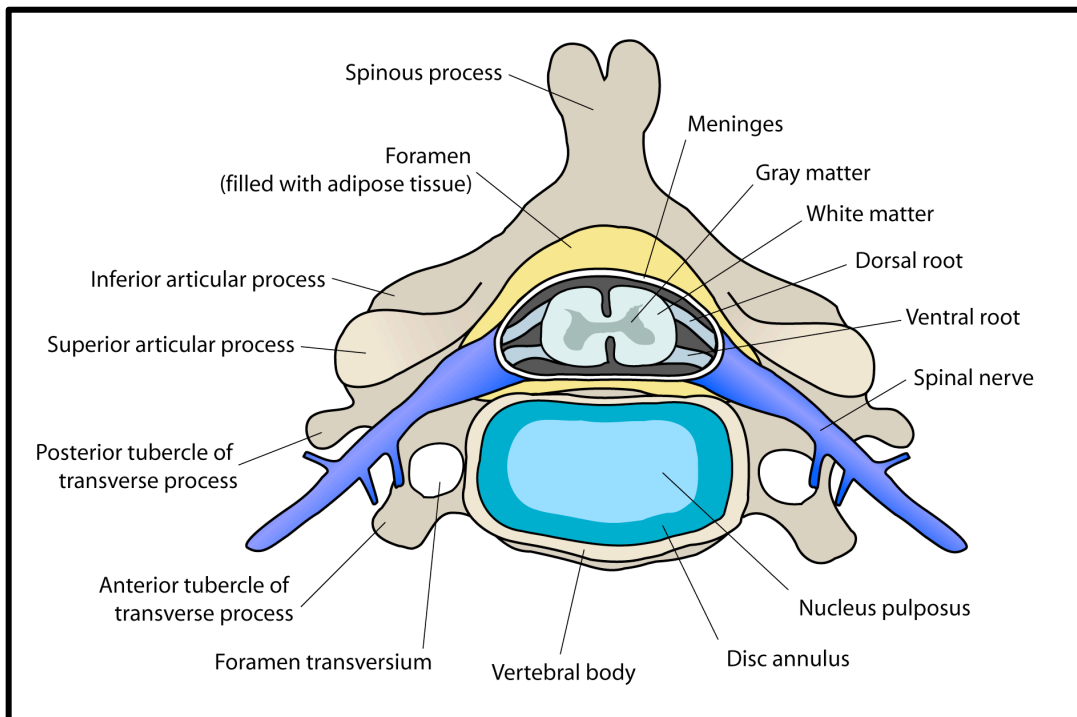

By user:debivort - Own work, CC BY-SA 3.0, <https://commons.wikimedia.org/w/index.php?curid=1675049>

Cross-section of a spinal vertebra and spinal cord

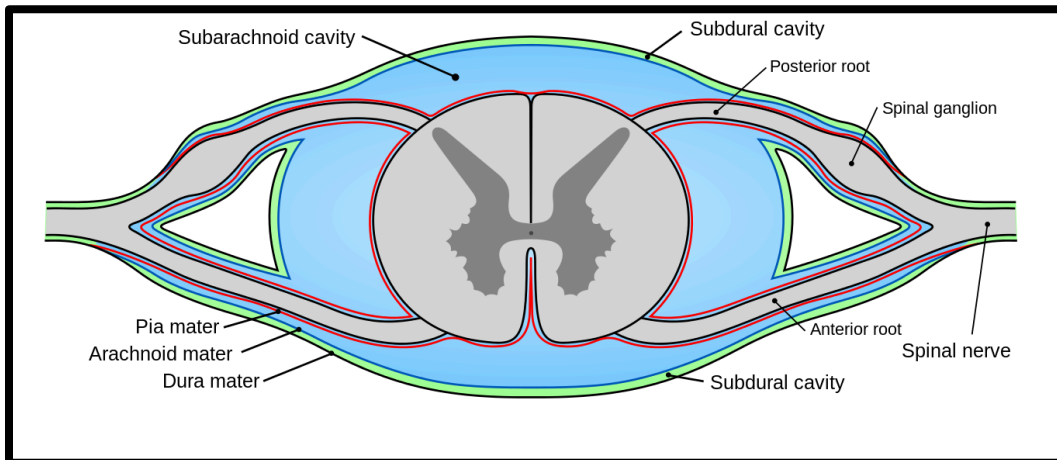

[https://commons.wikimedia.org/wiki/File:Spine Anatomy Kisco.JPG](https://commons.wikimedia.org/wiki/File:Spine_Anatomy_Kisco.JPG)

Cross-section of the spinal cord

Sprains and strains

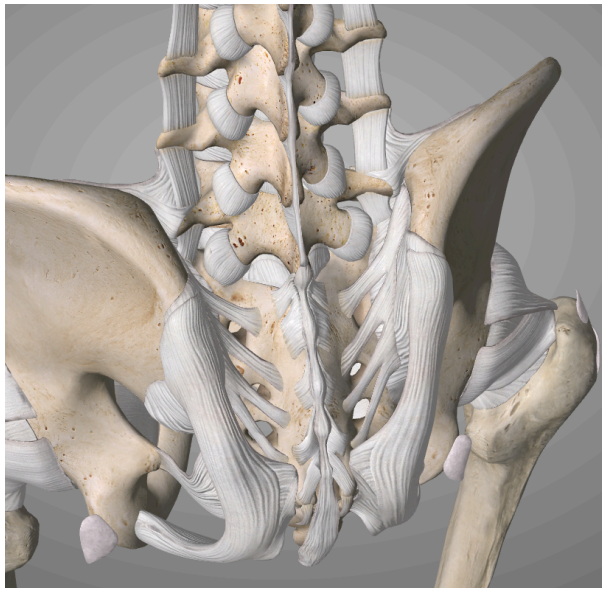

Ligaments of the lumbar spine

Sprain (aka torn ligament): Damage to one or more ligaments in a joint, which can be caused by trauma or by a joint being forced beyond its functional range of motion. The severity of a sprain can range from a minor injury which resolves within a few days, to a major rupture requiring surgical fixation and/or a period of immobilization.

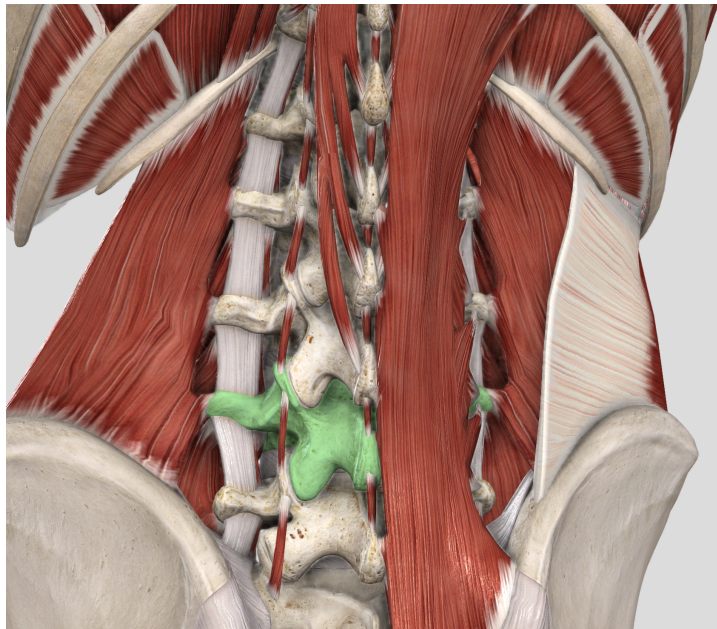

Cutaway view of paraspinal muscles and spinal ligaments of the lumbar spine. L4 vertebra highlighted.

Strain: As in “muscle strain”, a strain is a soft tissue injury that involves tearing of moving tissues, such as a muscle or tendon.

Disc-related conditions

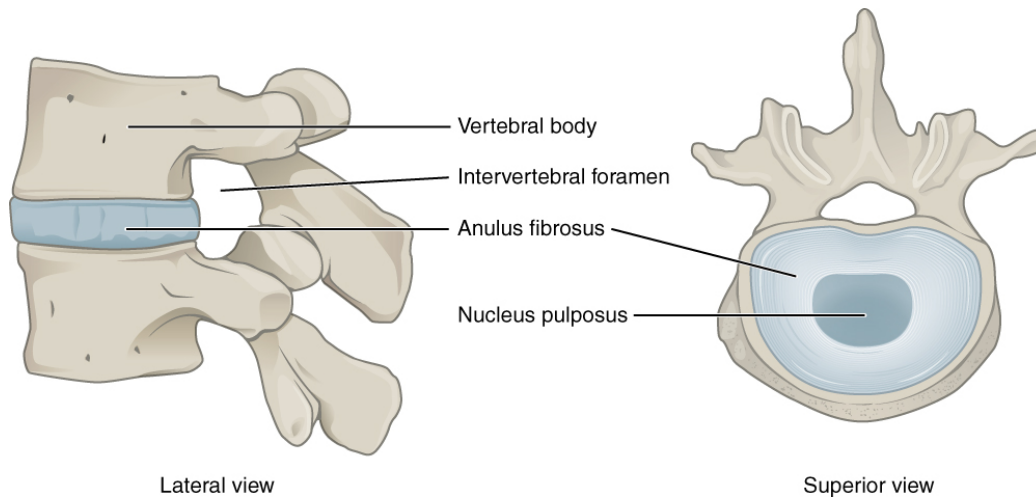

By OpenStax College - Anatomy & Physiology, Connexions Web site. <http://cnx.org/content/col11496/1.6/>, Jun 19, 2013., CC BY 3.0, <https://commons.wikimedia.org/w/index.php?curid=30131446>

Degenerative disc disease. This term describes the natural wear over time of an inter-vertebral spinal disc due to movement and minor injuries. This will cause the disc to gradually lose water and height, and for the annulus to weaken. As inter-vertebral discs lose height, it can impinge or put pressure on the nerves exiting the spinal column, causing pain and weakness. Typical radiographic findings and degenerative disc disease are black discs, a narrowing of the space between disk vertebrae, and osteophyte (bone spur) formation.

Bulging disc or disc protrusion: A condition in which the outermost layers of the annulus fibrosis are still intact but begin to bulge. In contrast to herniation, none of the gelatinous nucleus escapes. Bulging discs are common in middle-aged and older adults and are often completely asymptomatic. They have been compared to "gray hair" as a benign sign of aging.

Discitis: An inflammation of the vertebral disk which is often related to infection.

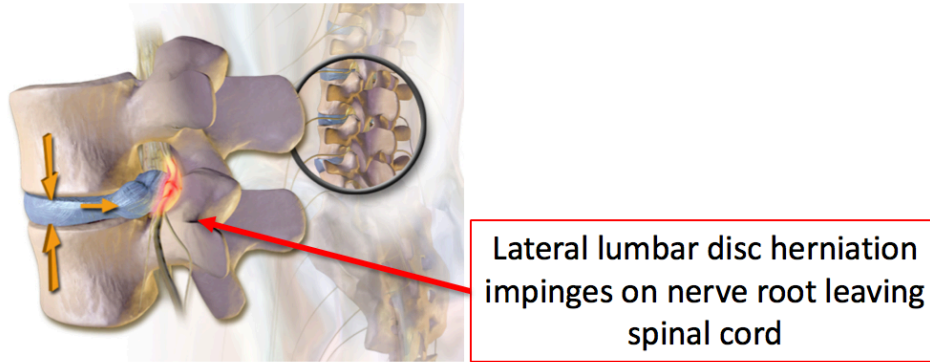

By BruceBlaus. When using this image in external sources it can be cited as:Blausen.com staff (2014). "Medical gallery of Blausen Medical 2014". WikiJournal of Medicine 1 (2). DOI:10.15347/wjm/2014.010. ISSN 2002-4436. - Own work, CC BY 3.0, <https://commons.wikimedia.org/w/index.php?curid=27796931>

Spinal disc herniation. A medical condition affecting the spine in which a tear in the outer fibrous ring of an intervertebral disc (the annulus) allows the gelatinous nucleus (nucleus pulposus) to bulge out through the tear. Disc herniation is usually due to age-related degeneration of the outer ring, although trauma or injury can cause this as well. This tear in the disc may result in the release of chemicals in the nucleus pulposus which can inflame the nerve. This may chemically induce pain even the absence of nerve root compression.

Vertebral conditions

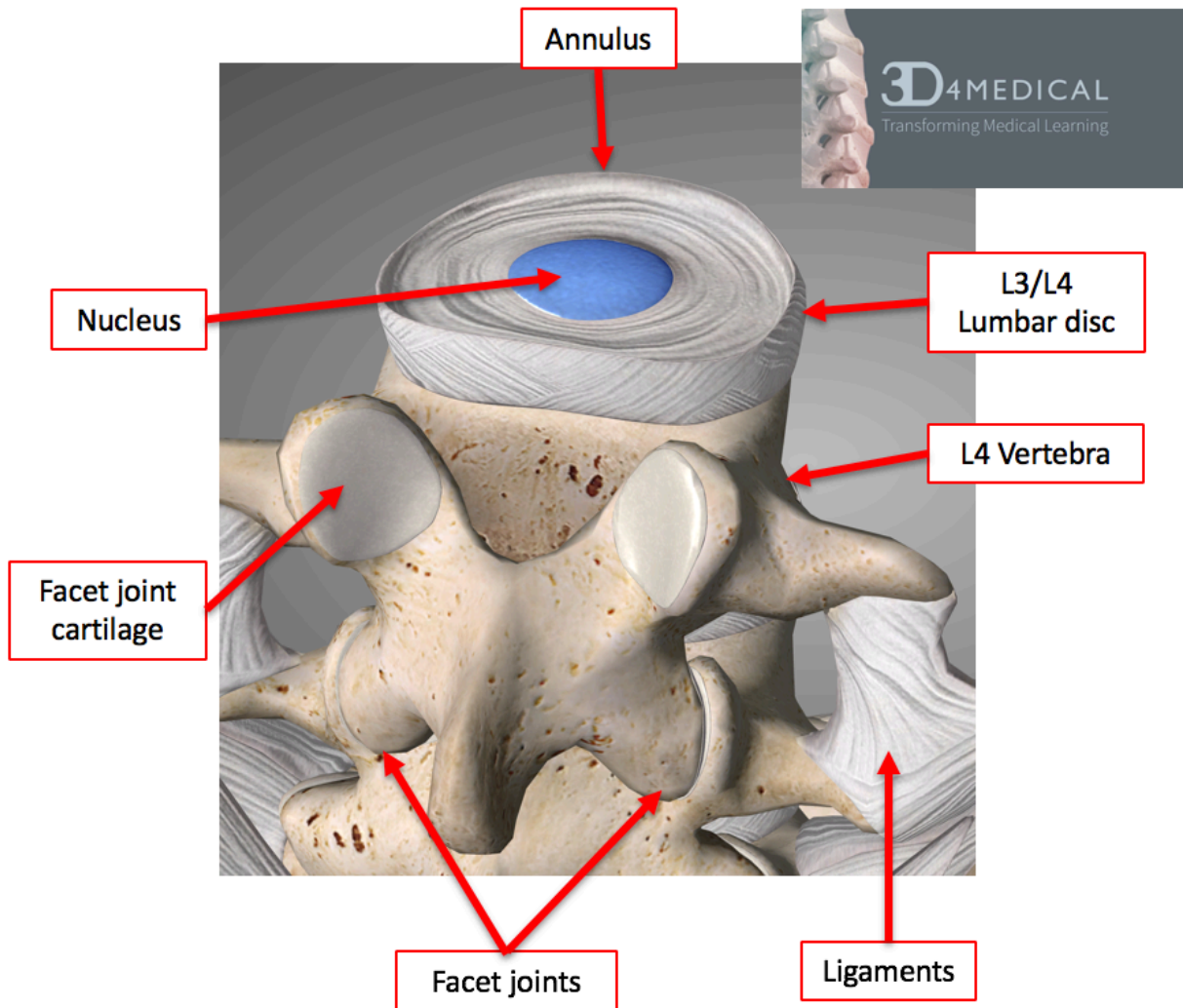

Facet joint: Joints between two adjacent vertebrae that guide their movement while keeping the vertebrae aligned.

Facet syndrome: A syndrome in which the facet joints degenerate to the point of causing painful symptoms. This is believed to be one of the most common causes of lower back pain, and is associated with osteoarthritis. It is often closely associated with degenerative disc disease, but is distinct from that.

Pars interarticularis: The part of the vertebra which is in between the facet joint and the vertebral body. A fracture here destabilizes the spinal alignment.

Spondylitis: An inflammation of the vertebra. **Ankylosing spondylitis** is an arthritic condition that can involve the spontaneous fusion of adjacent vertebrae.

Spondylosis. A condition of the spine resulting from age-related wear and tear on the spinal vertebrae. It is commonly associated with osteoarthritis and osteophytes in the facet joints. If the vertebrae of the neck are involved it is called cervical spondylosis, while if the lower back vertebrae are involved, is called lumbar spondylosis. *Spondylotic* myelopathy is spinal cord dysfunction associated with spondylosis. Not to be confused with **spondylitis** or **spondylolysis**.

Spondylolysis. An instability of the spine resulting from a fracture of the pars interarticularis, which can render the facet joint nonfunctional. If the pars interarticularis sustains a displaced fracture, the vertebra can move, creating a scissoring effect on the spinal cord and potentially spinal cord injury. Not to be confused with **spondylitis** or **spondylosis**.

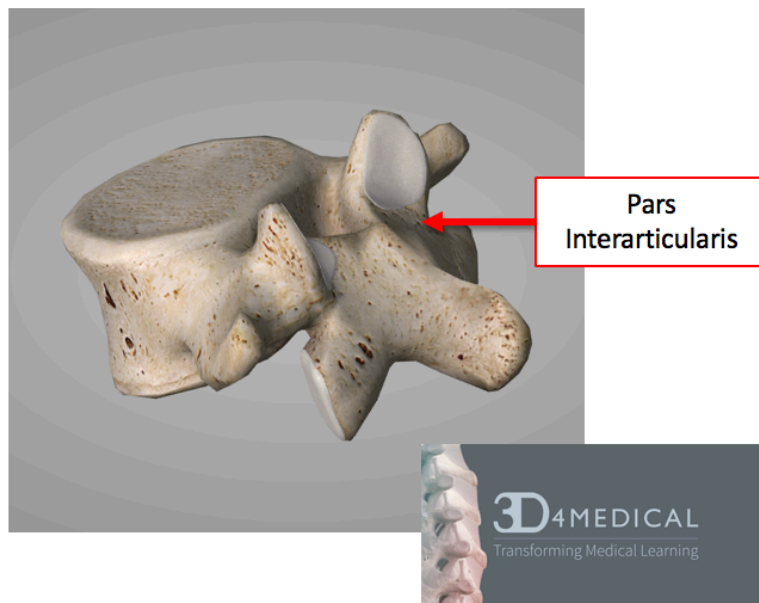

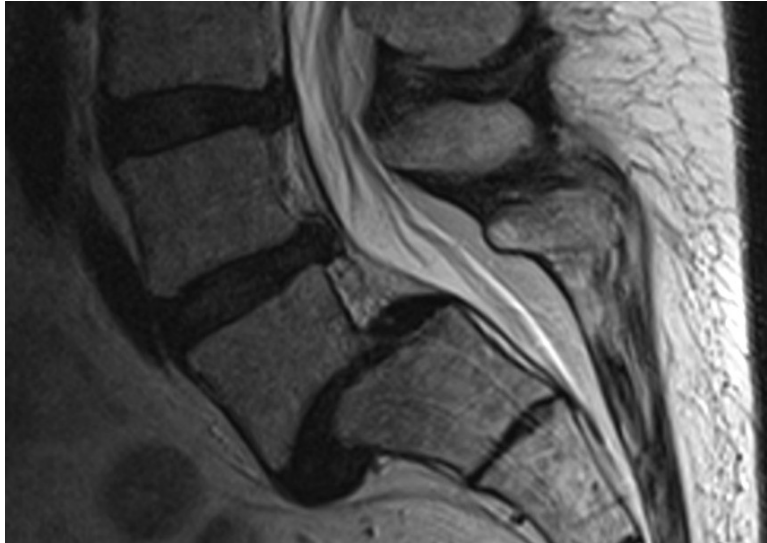

Grade 2 Spondylolisthesis

MRI of Spondylolisthesis By PumpingRudi - Own work, CC BY-SA 3.0,
<https://commons.wikimedia.org/w/index.php?curid=8580697>

Spondylolisthesis: A forward movement of a vertebra over the one beneath it. This can be associated with a variety of etiologies, including fracture of the pars interarticularis. Grade 1 spondylolisthesis refers to a 25% slippage (with percent being referring to the width of the vertebral body), grade 2 is 25-50%, grade 3 is 50-75%, grade 4 75-100 percent, and grade 5 is above 100%.

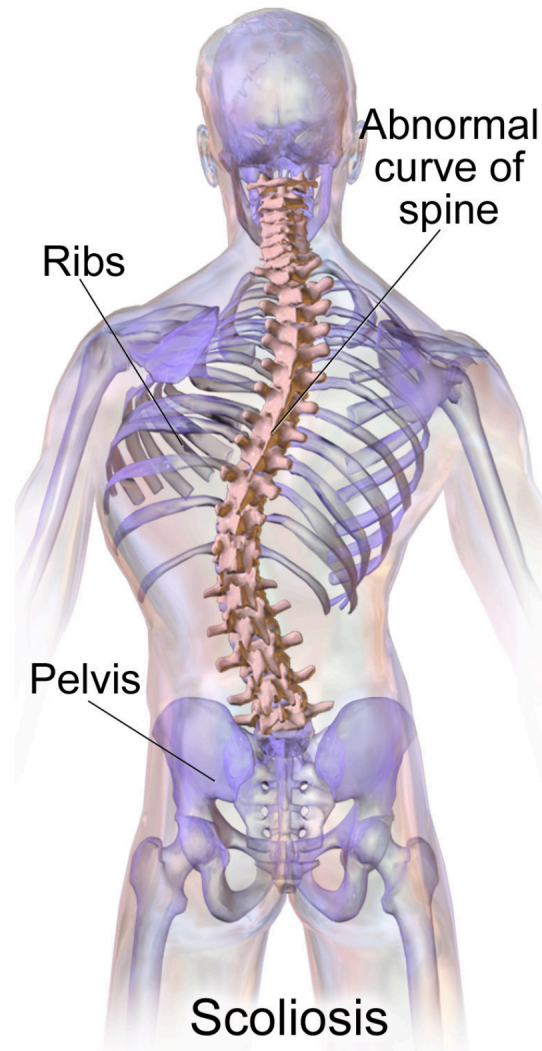

Blaesen.com staff (2014). "Medical gallery of Blaesen Medical 2014". WikiJournal of Medicine 1 (2). DOI:10.15347/wjm/2014.010. ISSN 2002-4436. [CC BY 3.0 (<https://creativecommons.org/licenses/by/3.0/>)], from Wikimedia Commons

Scoliosis. A medical condition where an individual spine curves to the side. This condition is often not painful.

Kyphosis: The normal thoracic spine exhibits a certain amount of curvature. Hyper kyphosis refers to curvature of the thoracic spine which exceeds normal limits.

Lordosis: The normal lumbar spine exhibits a certain amount of curvature. Hyper lordosis refers to curvature of the lumbar spine which exceeds normal limits.

Osteophyte: A boney projection, also called a bone spur. Osteophytes most often form where a tendon or ligament attaches to a bone in a joint.

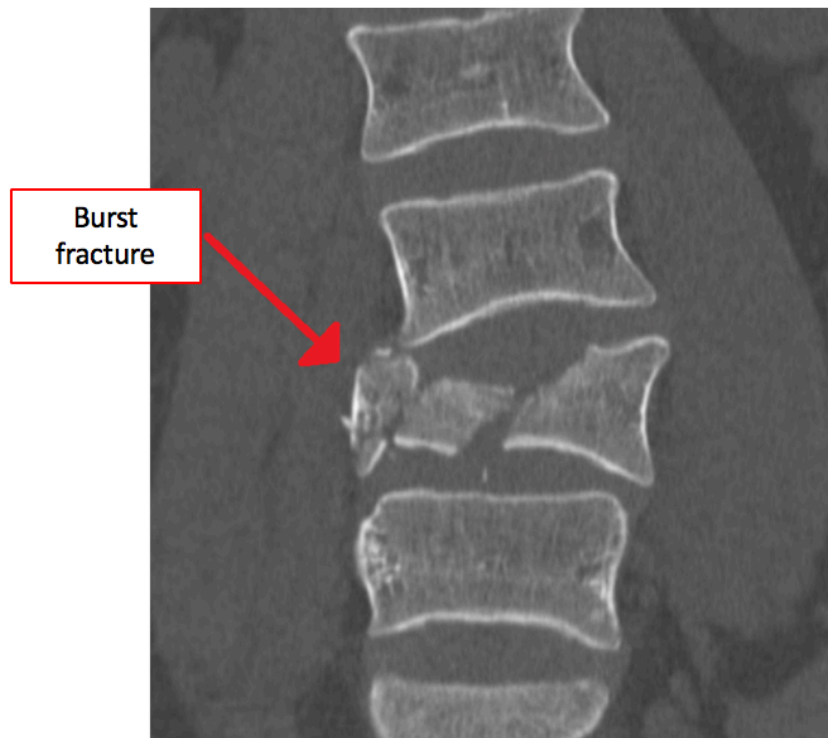

By James Heilman, MD [CC BY-SA 4.0 (<https://creativecommons.org/licenses/by-sa/4.0/>)], from Wikimedia Commons

Burst fracture - Vertebral: A vertebral burst fracture can occur due to a sudden severe compression of the spine, such as a traumatic injury secondary to falling and landing in a seated position. Burst fractures are associated with a high risk of spinal cord injury.

Kyphoplasty: a surgical procedure to repair a burst fracture, or a vertebra which is deteriorating from severe osteoarthritis. A cavity is created by a balloon within the vertebra, after which a highly viscous cement is injected. This this procedure is intended to restore vertebra height, and to stabilize the fracture

Vertebroplasty: a surgical procedure used to repair a compression fracture of the spine. It is performed by injecting a low viscosity bone cement into the vertebra, to stabilize a fracture. Well simpler than archival plaster, a risk factor is the leakage of the cement outside of the vertebra. this procedure does not attempt to restore normal vertebral height.

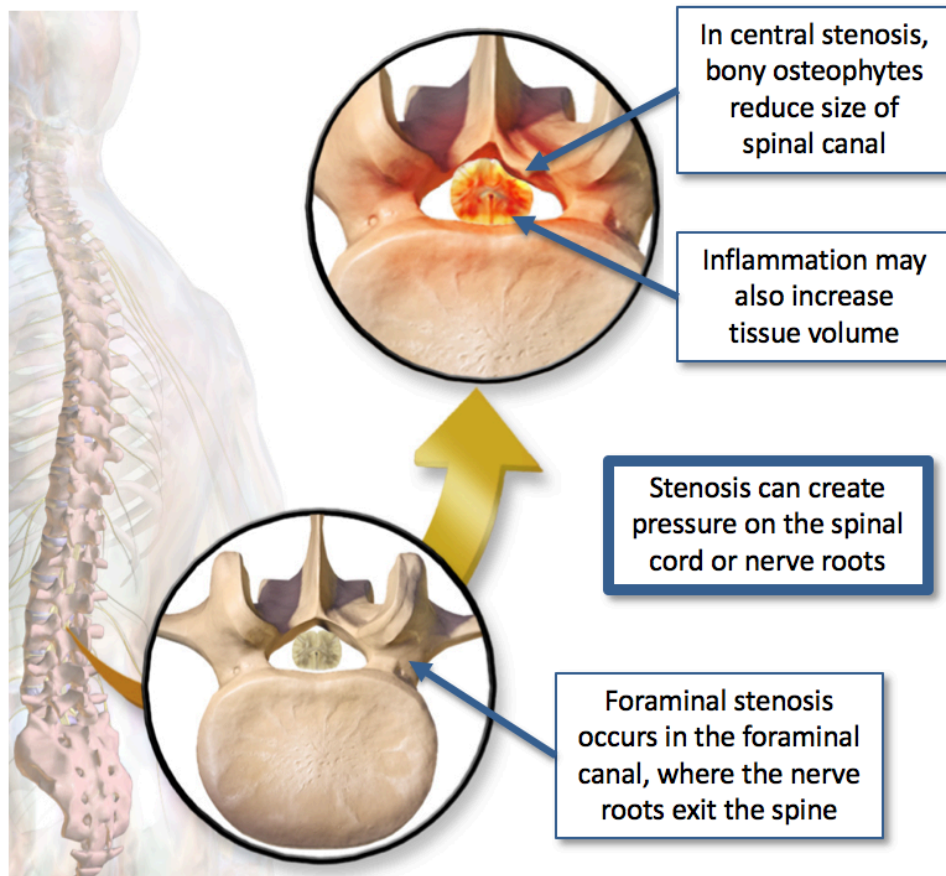

Blausen.com staff (2014). "Medical gallery of Blausen Medical 2014". *WikiJournal of Medicine* 1 (2). DOI:10.15347/wjm/2014.010. ISSN 2002-4436.

Stenosis. An abnormal narrowing of a bodily structure. When applied to the spine, central stenosis refers to the narrowing of the spinal canal, and subsequently to pressure on the spinal cord. Foraminal stenosis refers to a narrowing of the region where spinal nerve roots exit the spinal cord, and impingement of the nerve root.

Spine-Related Nerve Disorders

Cauda equina syndrome: Cauda equina is literally "the horses tail", and refers to the lumbar portion of the spinal cord, where the spinal cord transitions from a single structure to numerous fibers, and looking like a horse's tail. Cauda equina syndrome refers to a set of symptoms that appears when the cauda equina is compressed or damaged. Symptoms of cauda equina syndrome include loss of bowel and bladder control, sexual dysfunction, and pain which radiates into the lower extremities. In severe cases, cauda equina syndrome can progress to paraplegia.

Myelopathy: Refers to any neurological dysfunction associated with the spinal cord. This can be caused by a variety of pathologies, ranging from stenosis, inflammation, disease or injury. When myelopathy is inflammatory in nature, it is known as myelitis. Clinical signs of myelopathy include weakness, pathological reflexes, clumsiness, muscle atrophy, the circulations, or sensory deficits.

Myelitis: Myelopathy associated with inflammation.

Sacroiliac (SI) joint

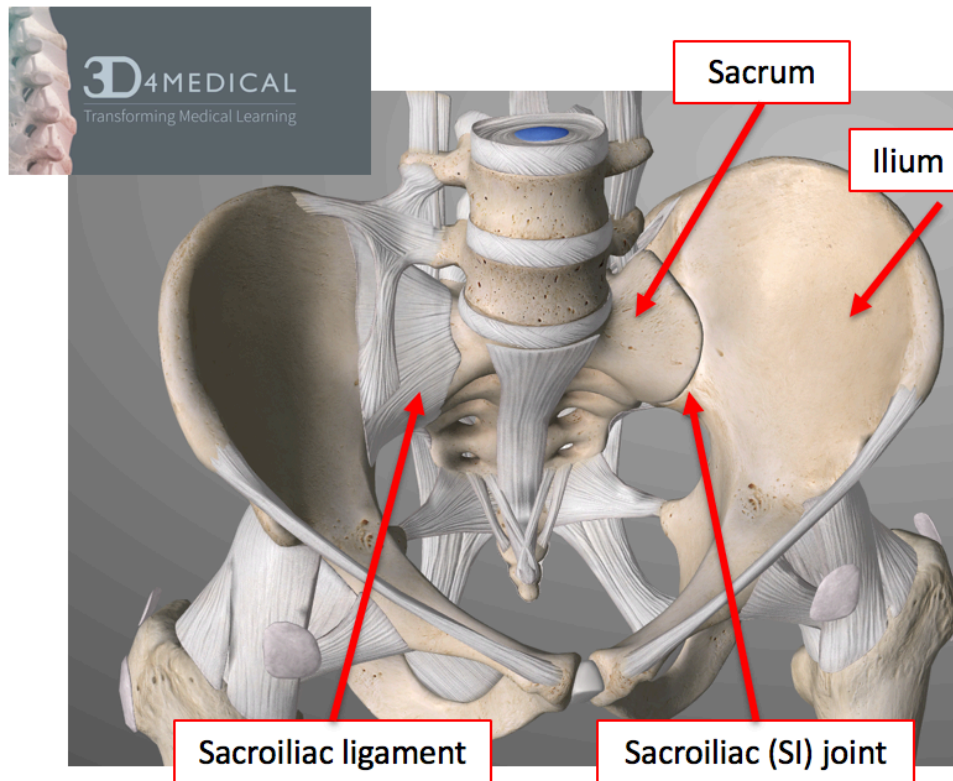

Sacroiliac or SI joint. The joint between the sacrum and the ilium. This joint connects the sacrum or lower part of the spine, with the ilium or hipbones. Not to be confused with sciatica, which is pain that radiates down the leg due to impingement of the sciatic nerve.

Spinal surgical procedures



A herniated disc may compress a nerve root or the spinal cord. Removing the extruded part of the disc decompresses the spinal cord or nerve root.

By Ortenau Klinikum (Ortenau Klinikum) [GFDL (<http://www.gnu.org/copyleft/fdl.html>) or CC BY 3.0 (<https://creativecommons.org/licenses/by/3.0/>)], via Wikimedia Commons

Discectomy: The surgical removal of a vertebral disc, or more commonly, the surgical removal of a herniated disc protrusion.

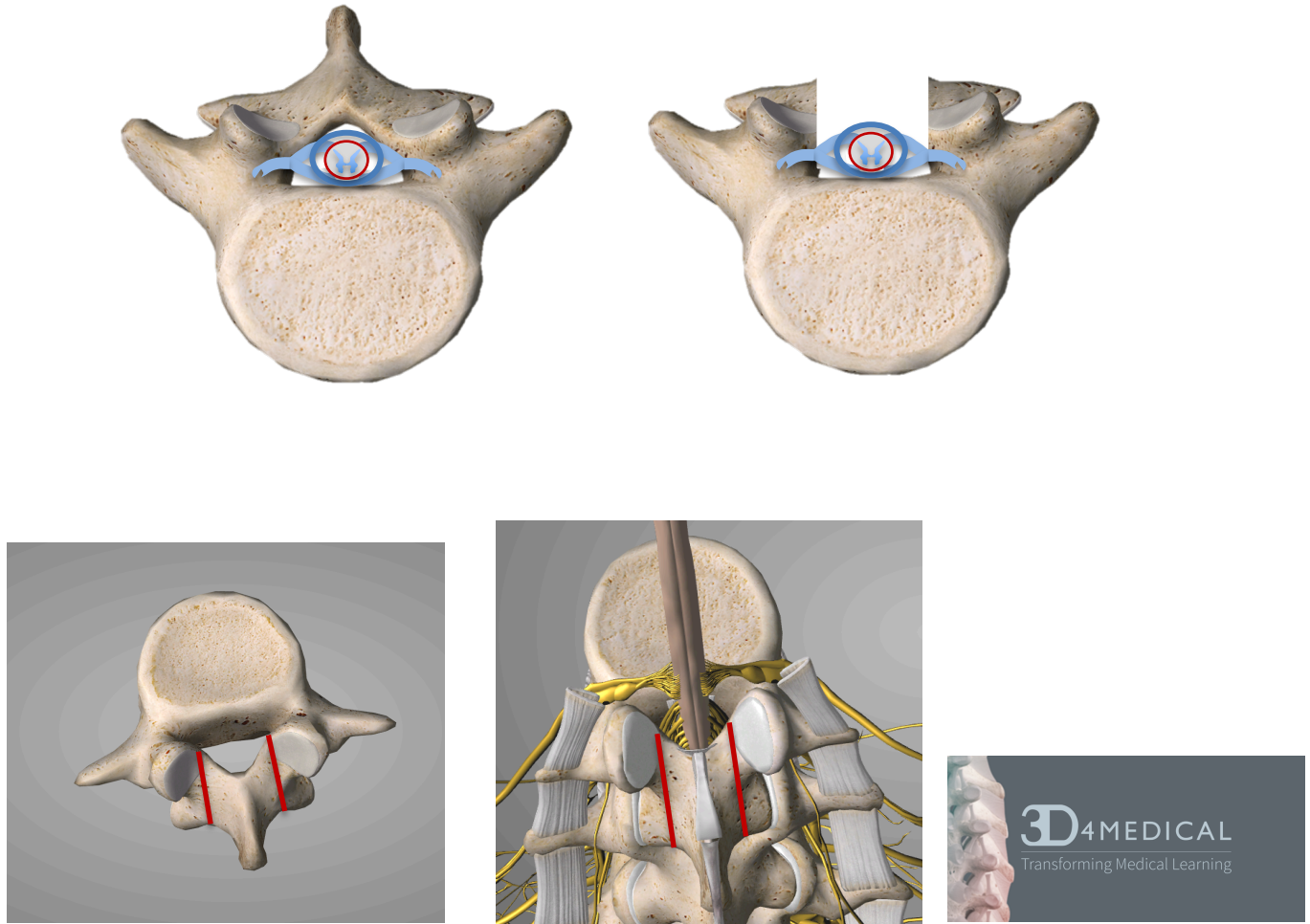

Laminectomy: The lamina is a bony projection which surrounds the spinal cord, and extends out the back (dorsal) side of a vertebra. The lamina creates a bony tunnel called the spinal canal. Herniated discs, osteophytes or inflammation can place pressure on the spinal cord, or on nerve roots exiting the spinal cord. This pressure can be released via surgical removal of the lamina (laminectomy). Laminectomy “makes a vertebra into a convertible”, and in so doing creates more room and decompresses the spinal cord. It is often performed concurrently with a discectomy.

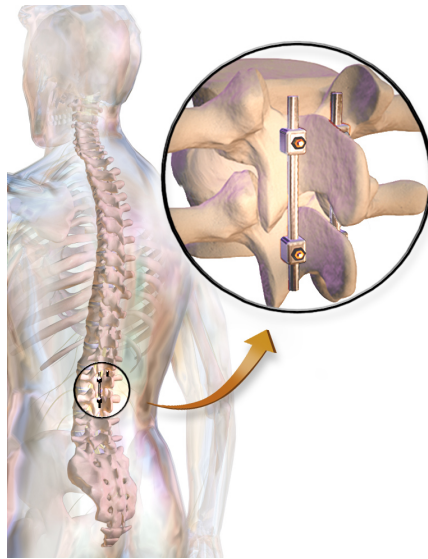

Blausen.com staff (2014). "Medical gallery of Blausen Medical 2014". WikiJournal of Medicine 1 (2). DOI:10.15347/wjm/2014.010. ISSN 2002-4436. - Own work, CC BY 3.0, <https://commons.wikimedia.org/w/index.php?curid=29987031>



By PumpingRudi - Own work, CC BY-SA 3.0, <https://commons.wikimedia.org/w/index.php?curid=8583136>

Spinal fusion: Any one of many surgical techniques used to join two adjacent vertebrae into a single bony structure. Some spinal fusion techniques approach from the back, and use “rods and screws” to join vertebrae (see above). Other techniques approach the spine from the front (anterior approach) and install a metallic spacer called a “cage”, so-called as some are a porous almost sponge-like material (resembling a cage) through which the bone can grow.

Allograft & autograft: An allograft refers to sterile bone derived from another source, typically a cadaver, which is the transplanted into a patient for a fusion procedure or other orthopedic repair. In contrast, an autograft refers to bone harvested from one part of the body, and

transplanted somewhere else in the same individual. This method has less risk of rejection than allograft, but may create a chronic pain condition in the site where the bone was harvested.

Arthrodesis: Successful fusion of two bones

Internal fixation: The use of implants such as screws, rods or cages in order to promote the healing of a fracture, or to enable the fusion of two adjacent vertebra.

Pseudarthrosis: The failed fusion of two bones

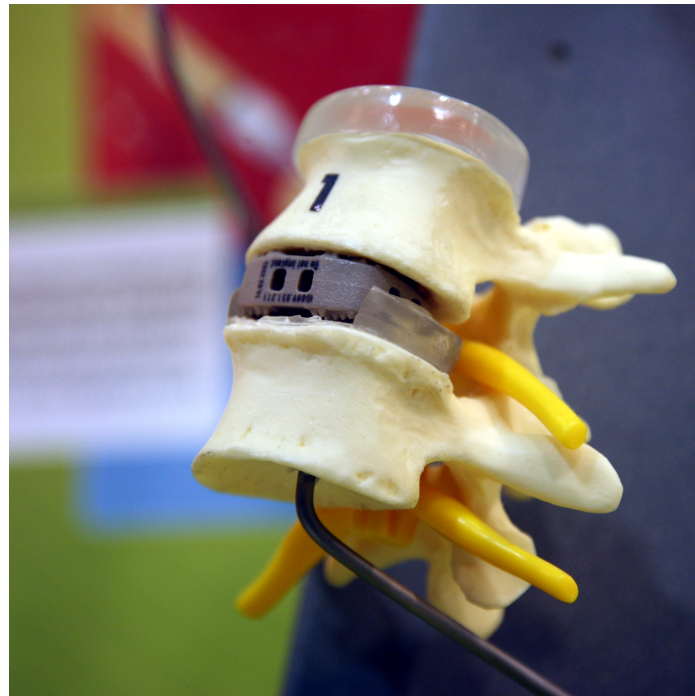

Artificial disc arthroplasty: The surgical replacement of arthritic, degenerated or necrotic joint or joint surface with prosthesis. Like a fusion, the disc is removed. Unlike a fusion with a cage, the artificial disc fuses to the vertebra above and below, but preserves movement in the joint.

Other terms

Ankylosis: A stiffness and sometimes the spontaneous fusion of a joint, often associated with arthritis.

Annular tear: a tear in the annulus of intervertebral disc

Annulus fibrosis: the outer layer of an inter-vertebral disc, which is comprised of numerous layers of fibrous material.

Arthroplasty: The surgical repair or remodeling of a diseased or damaged joint

Bulging disc (aka herniated disc, ruptured disc, disc protrusion, slipped disc, and annular tear): Terms whose meaning is closely related, but whose distinctions are poorly defined. A bulging disc is a malformation of inter-vertebral disc, characterized by an abnormal bulge, especially when that bulge impinges on the spinal cord or a nerve root. In common usage, the term bulging disc is sometimes used to imply the least severe version of this condition, followed by disc protrusion, and then ruptured or herniated disc.

Disc degeneration: in age-related process which involves a decreased level of fluid content, in a weakening of the structural and functional integrity of the spinal disc

Disc herniation: Occurs when an annular tear allows the escape of some of the gelatinous material inside a disc.

Discectomy: a spinal procedure intended to remove problematic disc material that may be bulging or herniated.

Failed back surgery syndrome: a controversial term, that describes continued pain after back surgery. It has been played out that no other medical procedure has a comparable term, nevertheless this term is used in the scientific literature.

Foraminotomy: A surgical procedure involving the removal of material obstructing the foraminal canal for the purpose of decompressing a nerve root. This may be bony material such as osteophytes, or material from a bulging or herniated disc.

Kyphosis: the normal outward curvature of the thoracic spine. **Hyper kyphosis** refers to excessive curvature.

Laminotomy: A surgical procedure involving the partial removal of the lamina. (-otomy refers to cutting into or partial removal of a bodily structure.)

Lordosis: The normal inward curvature of the lumbar spine. **Hyper lordosis** refers to excessive curvature.

Nerve root: The segment of a nerve where it exits the spine.

Nucleus pulposus: the gelatinous center of an intra-vertebral disc, which makes the disk more pliable. Like a jelly doughnut, the annulus fibrosis surrounds the gelatinous Nucleus pulposus.

Radiculopathy: pain caused by a compressed nerve root near the spine, which then radiates away along the path of the nerve. Thus, a compressed lumbar nerve root may create radiculopathy or pain which radiates into the lower extremities

Radiofrequency (RF) procedure: An interventional procedure involving insertion of a large diameter needle, the tip of which contains a microwave emitter. These microwaves are used to damage a nociceptive nerve, in the hope of reducing or eliminating pain.

Rhizotomy: The surgical severing of a nerve. In chronic pain patients a common procedure is a facet rhizotomy, the severing or ablation of a facet joint's sensory nerve.

Diagnostic procedures

Discogram: A diagnostic procedure involving the insertion of a needle into an intervertebral disc, and pressurizing it with saline fluid or radiographic dye. If the pressure increases the patient's typical pain, it is believed to indicate that the disc being tested is the cause of the patient's pain. Subsequent x-ray may be able to identify the location of an annular tear, if the dye leaks out of the disc there.

Electromyogram (EMG): a diagnostic test involving the insertion of needles into the muscles, in administering electrical shocks. This test allows the assessment of muscle and nerve function.

Facet block: A procedure that has both diagnostic and treatment purposes. It involves injection of anesthesia and steroid such as Cortisone into a facet joint. If pain relief results from the procedure, it is presumed that the facet joint was the origin of the pain.

Myelogram: A radiographic study involving the injection of dye into the spinal canal, in order to better visualize the spinal cord and nerve roots.

Nerve conduction study (NCS): A type of electromyogram focusing on nerve conduction and potential nerve dysfunction. This is often used to assess possible impingement of a nerve root, impingement of a nerve at the nerve root, in other possible sites. For example, in the upper extremities, nerve conduction may be obstructed by compressed nerve at the cervical nerve root, at the thoracic outlet, at the elbow (epicondylitis), when the carpal tunnel.

Spinal surgery considerations

Does a spinal fusion feel good?

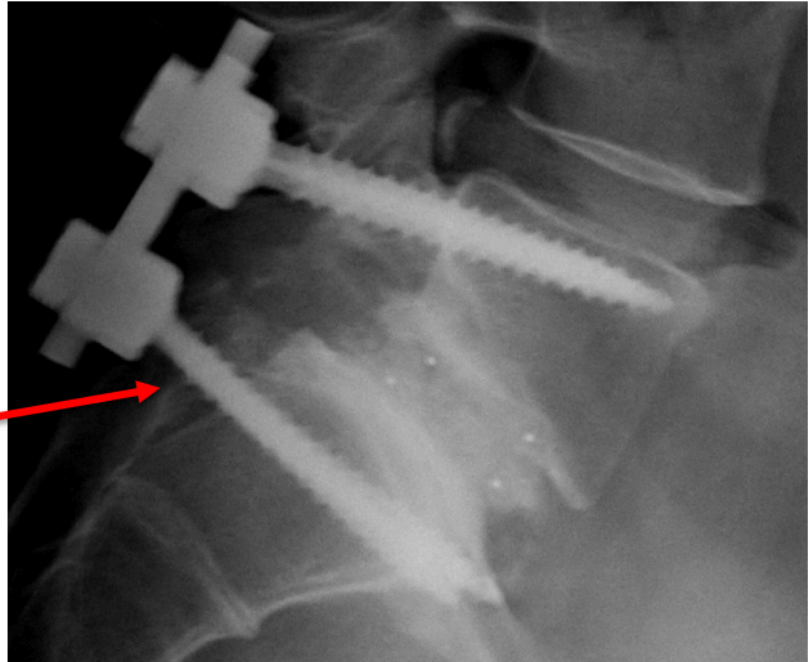

By PumpingRudi - Own work, CC BY-SA 3.0, <https://commons.wikimedia.org/w/index.php?curid=8583136>

Indications for spinal surgery: There are a number of reasons why spinal surgery is indicated. These include the following:

1. Vertebral fracture
2. Central or foraminal stenosis
3. Disc herniation
4. Conditions producing spinal instability, such as spondylolisthesis
5. Nerve conduction study (NCS) demonstrates the compression of a spinal nerve
6. Spinal tumor
7. Chronic pain

In many cases, a surgeon can determine with considerable certainty what the objective outcome of the surgery will be: Will the instrumentation stabilize the spine? Will the vertebrae fuse together? But how the operated area *feels* after the surgery is a complex matter that is strongly influenced by psychosocial variables. When pain is the primary reason for proceeding to surgery, then the primary goal of the surgery is to change behavior (e.g. stop taking opioids, return to work, or to say “My pain is only a two now, and that is fine with me.”) When the goal of surgery is to change in the report of subjective symptoms, other behavior change (e.g. opioid cessation, return to work), or if surgical outcome is dependent on patient motivation in physical therapy post-surgically, then behavioral assessment is indicated.

Part II: Neuromodulation And Other Electrical Treatments For Pain

Neuromodulation

Neuromodulation has been defined by the International Neuromodulation Society as “the alteration of nerve activity through targeted delivery of a stimulus, such as electrical stimulation or chemical agents, to specific neurological sites in the body”.¹ Although in the broadest sense neuromodulation refers to anything that modulates nerve activity (e.g. neurotransmitters, magnetic fields, etc.), in the clinical setting this term most commonly implies a treatment using an implanted electrical device or intrathecal drug delivery device.

Implanted Electrical Neuromodulation Therapies

Spinal cord stimulation (SCS): An electrical neuromodulation treatment that alters nerve functioning by stimulating the spinal cord. Electrodes are surgically implanted in the spine near the spinal cord, and are used to broadcast electrical signals. These signals induce complex electrochemical reactions in the nervous system. This procedure is primarily used to alter neural functioning for analgesic purposes, and is an alternative to conventional surgery or chronic opioid therapy.

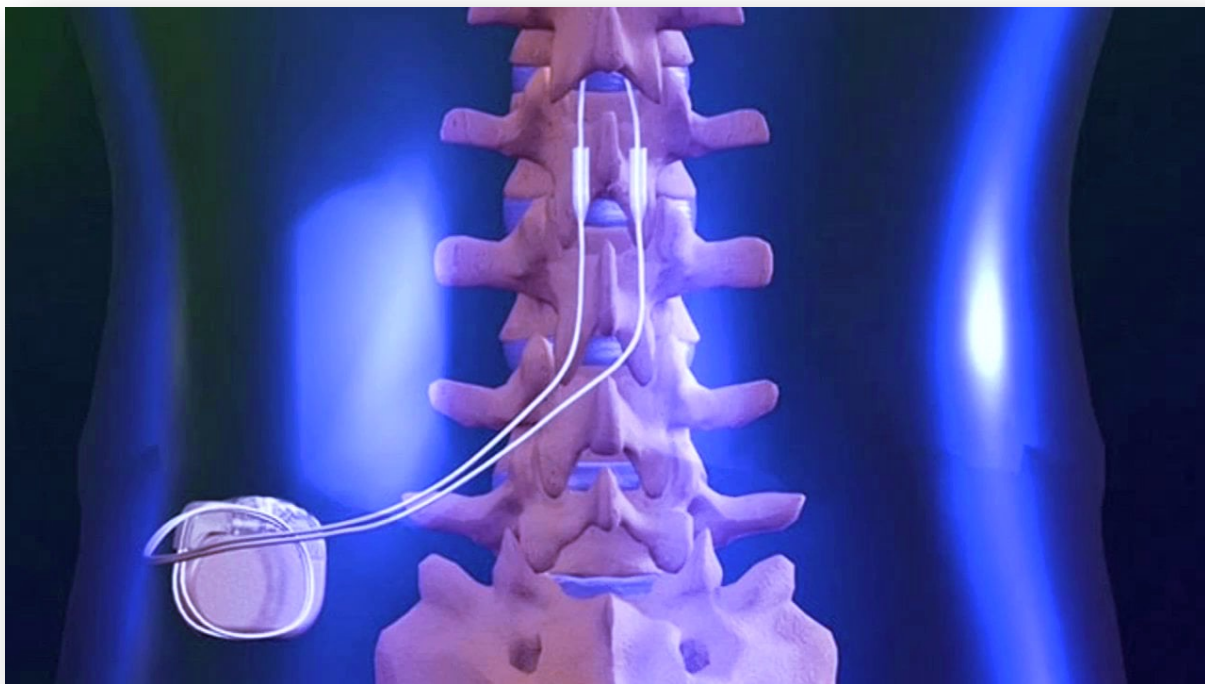

Implanted spinal cord stimulator

Nociceptors/Nociception: Nociceptors are sensory receptors designed to detect actual or potential tissue damage. Nociceptive signal, upon arrival in the brain, are often interpreted as pain.

Paresthesia: An altered or abnormal sensory experience, most commonly perceived as a tingling sensation. When used for analgesic purposes, many electrical neuromodulation treatments replace pain with this tingling paresthesia, which is similar to the feeling of your foot being “asleep.” The electrical signal created by SCS treatment may overwrite the signal conducted by nociceptive nerves with what could be thought of as “white noise” which the brain does not recognize as pain, and which is typically experienced as tingling. Most patients find the paresthesia to be significantly less aversive than the pain.

Peripheral nerve stimulation (PNS): An electrical neuromodulation treatment that alters nerve functioning by stimulating peripheral nerves as opposed to the spinal cord or brain.² Recent studies suggest that electrical stimulation of peripheral nerves leads to inhibitory input to the pain pathways at the spinal cord level.³ PNS is most effective in the treatment of neuropathic pain (e.g., posttraumatic or diabetic neuropathy) when there is a “distal” nerve lesion (i.e. distant from the spine). Specific peripheral nerve stimulation techniques used for pain relief:

- **Dorsal root ganglion stimulation (DRG stimulation) or nerve root stimulation:** The use of nerve stimulation technology to stimulate the dorsal root ganglion (where the nerve root exits the spine) or the actual nerve root for pain relief. It is believed that this technique allows for the production of highly localized paresthesias.^{4,5}
- **Occipital nerve stimulation:** The use of nerve stimulation technology to deliver electrical stimulation to the occipital nerve to control intractable headaches or craniofacial pain.^{6,7}
- **Percutaneous electrical nerve stimulation (PENS):** An electrical neuromodulation technique using acupuncture-like needles which are inserted into soft tissues or muscles to electrically stimulate nerve fibers. PENS can be likened to an acupuncture-TENS hybrid (see TENS), and has been used to treat pelvic and urinary disorders. There is good evidence that PENS improves pain and function compared to placebo; however, there is no evidence of long term benefit⁸⁻¹².
- **Sacral nerve stimulation (aka sacral neuromodulation or urologic nerve stimulation):** The use of nerve stimulation technology for the purpose of improving urinary function or reducing pain.^{13,14}
- **Vagus (Vagal) Nerve Stimulation:** The use of nerve stimulation technology to deliver electrical stimulation to the vagus nerve. This procedure has been used for epilepsy and depression.¹⁵⁻¹⁸

Deep brain stimulation (DBS): The use of nerve stimulation technology to deliver electrical stimulation to targeted areas of the brain. This procedure has been used to treat Parkinson's disease, but a recent meta-analysis suggests while it may produce improved motor functioning, it may decrease cognitive functioning.¹⁹ DBS has also been used to treat epilepsy²⁰, major depressive disorder²¹, obsessive-compulsive disorder and other psychiatric conditions.^{20,21} Studies with DBT for pain have not shown a significant benefit.²² As this procedure involves inserting electrodes into the center of the brain, it is a very invasive treatment.

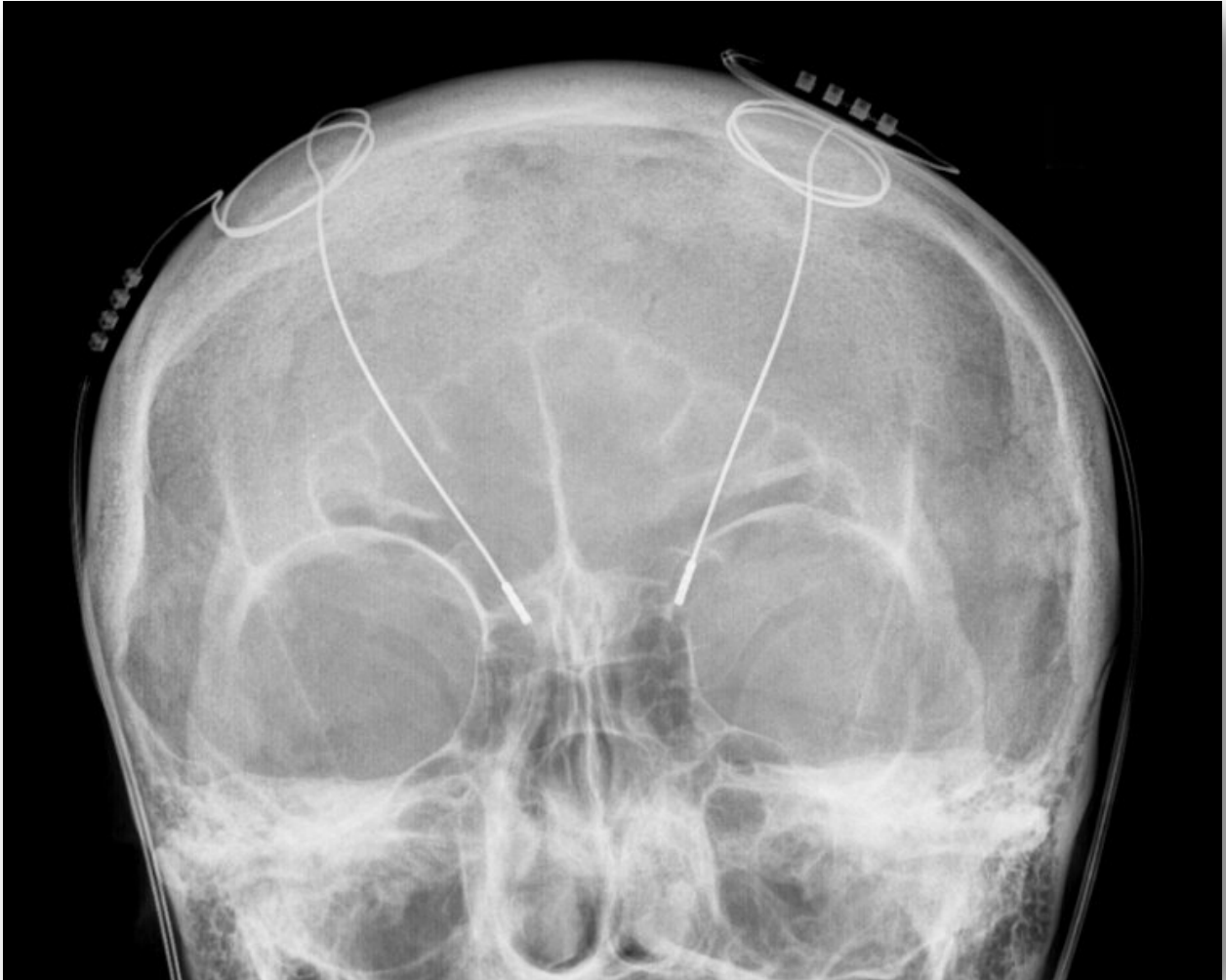

Deep Brain Stimulation By Hellerhoff
[CC BY-SA 3.0 (<http://creativecommons.org/licenses/by-sa/3.0>)], via Wikimedia Commons

Basic Neuromodulation Concepts

Pulse generator: A unit containing a battery and electronic circuits necessary to produce an electronic signal used to modify the functioning of the nervous system. The pulse generator can be attached to one to four leads, and be placed in any one of several different locations in the body. This includes above the waistline in the back, flank or abdomen, or just below the collar bone depending on what the patient prefers. Most pulse generators must be recharged about once a week, and can be recharged through the skin.

A handheld remote device that is similar to a television remote serves to control the implanted pulse generator. In the case of SCS though, the pulse generator controlled by the remote is inside the patient's body! Although SCS remotes are simpler than the typical TV remote, SCS treatment still requires some cognitive ability on the part of the patient to operate the device. Thus, SCS is contraindicated for patients who for cognitive reasons are unable to operate the remote.

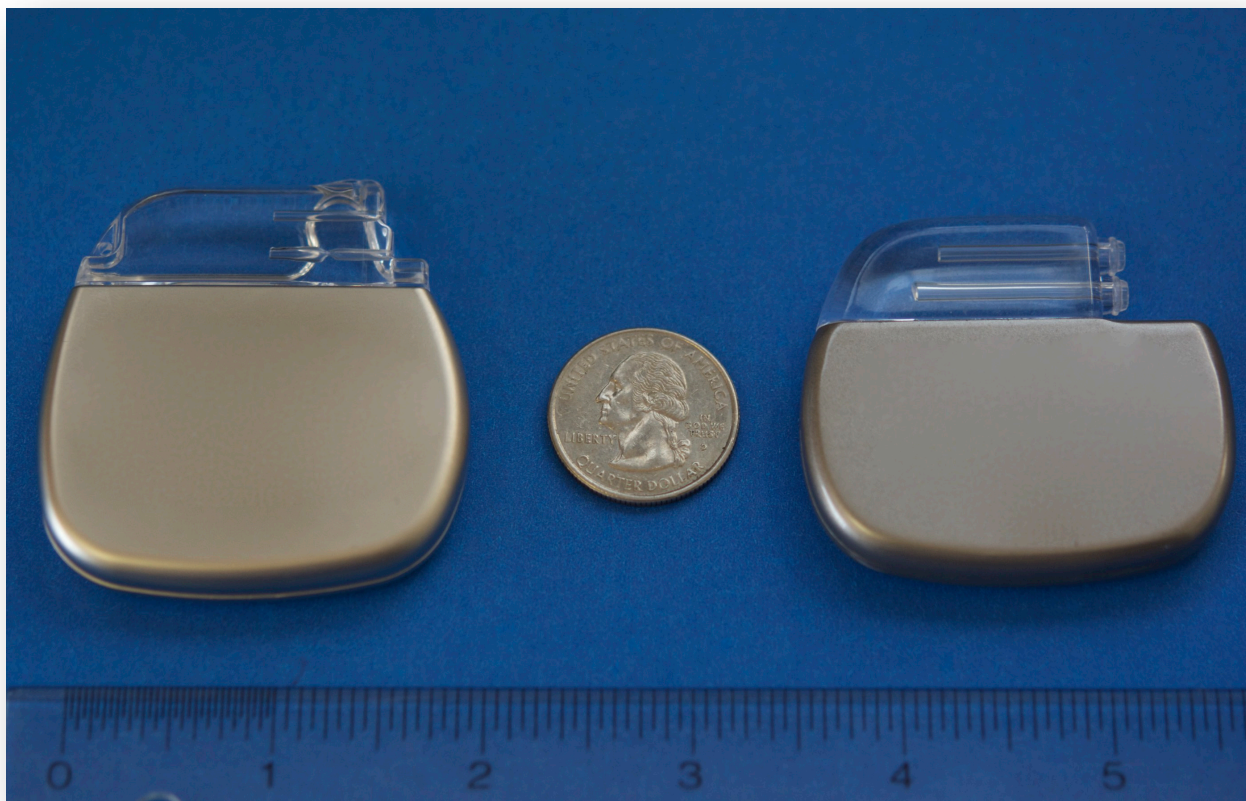

Implantable pulse generators from two manufacturers showing relative size. The one on the left does not preclude the patient from having an MRI, while the smaller one on the right does.

Photo © 2017 by Daniel Bruns

Lead: An insulated wire with electrodes at the end used by SCS to deliver the electrical treatment. These electrodes apply stimuli to a targeted neural structure (e.g. brain, spinal cord, ganglia, or peripheral nerve). At the time of this writing, some leads have up to 20 electrodes.

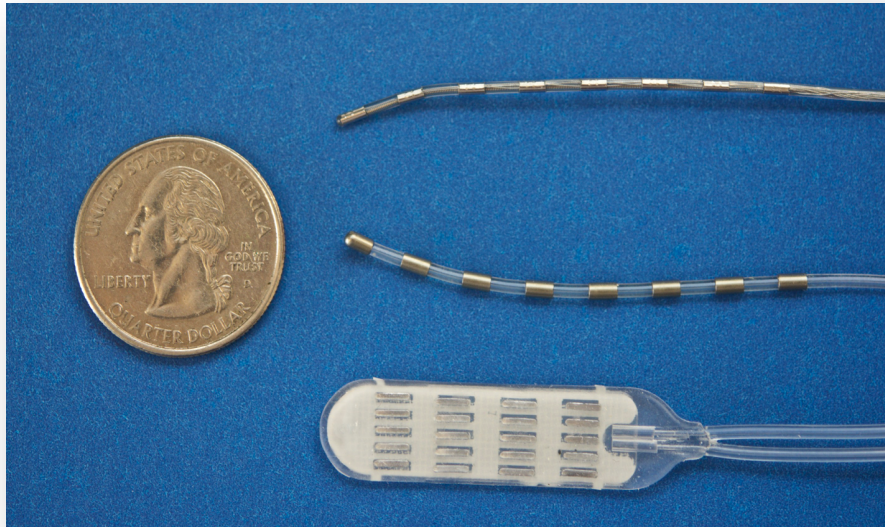

Percutaneous and paddle leads. Photo © 2017 by Daniel Bruns

Percutaneous lead: Percutaneous means through the skin, and it refers to the surgical method of inserting the lead through the skin using a needle. These leads are cylindrical, 1-2 mm in diameter, and have electrodes which are the same diameter as the wire to which they are attached. Thus, these leads can be implanted via a large bore needle in a trial, and later permanently anchored to ligaments or other structures for permanent implantation. Percutaneous electrodes are circumferential, that is they are exposed all the way around the lead, so they send a signal in all directions. Percutaneous leads are the least invasive leads to implant, and the most commonly used. Percutaneous leads are commonly installed in pairs.

Paddle lead: A lead that ends with a paddle-shaped electrode that is much larger than the percutaneous leads. Paddle leads have several advantages. 1) While percutaneous leads broadcast their energy 360°, paddle leads have some ability to focus the direction of the energy that is broadcast, and are installed closer to the spinal cord; 2) Due to their larger size, paddle leads may have more electrodes; and 3) Paddle leads have greater stability. Since the paddle has a wider shape, it is easier to anchor to spinal tissue, and there is a greater surface area for scar to form over it and fix it in position. In contrast, the smaller shape of percutaneous leads to a higher lead migration rate (i.e. the lead can move). If the lead moves, the benefits of stimulation may stop or be greatly reduced. The disadvantage of paddle leads is that because of their larger size, their implantation is more invasive. To install a paddle lead, part of the vertebra must be removed (a laminectomy), but the patient may benefit from this laminectomy procedure as well. Paddle leads have been associated with more post-operative complications, but fewer long-term reoperation rates vs. percutaneous leads.²³ Overall, paddle leads are believed to deliver a superior stimulation to the spinal cord.

The microstimulator transmitter unit (aka “wearable antenna assembly”) is a paddle-like device that is a few inches long and worn externally. This unit transmits power through the skin to the microstimulator, and also transmits the stimulation program. NOTE: *Images are are not to scale.*



This cylindrical microstimulator is only 1.3 mm (1/20th of an inch) in diameter and a few inches long. It looks similar to a standard SCS electrodes. However, this unit contains both electrodes and the circuit board of a micro-sized pulse generator! It is too small to contain a battery or power source, and so power must be transmitted through the skin

Implantable microstimulator. Image ©2018 by Daniel Bruns, PsyD

Microstimulator (aka Stimwave®): A miniaturized SCS device that uses wireless technology. Remarkably, the circuit board of a microstimulator is small enough to fit inside of a 1.3mm cylindrical electrode. As a battery cannot fit in a space that size, the unit is powered externally by a transmitter unit (aka “wearable antenna assembly”). This technology has pros and cons. The advantage of this technology is that the microstimulator can be implanted without surgery, using only a needle. As there is no implanted pulse generator, there is no disfiguring lump,* and the patient can still have an MRI. The con is that this unit requires that the patient wear an external paddle-like transmitter, which creates a different burden of treatment.

* Note that a disadvantage of implanted pulse stimulators is that they often produce an unsightly lump. This is especially likely to happen with a person who has a small frame, low body fat, good muscle tone, and who wears form-fitting clothing. In these persons, a lumbar spinal stimulator can look like “a can of chewing tobacco in your back pocket.”

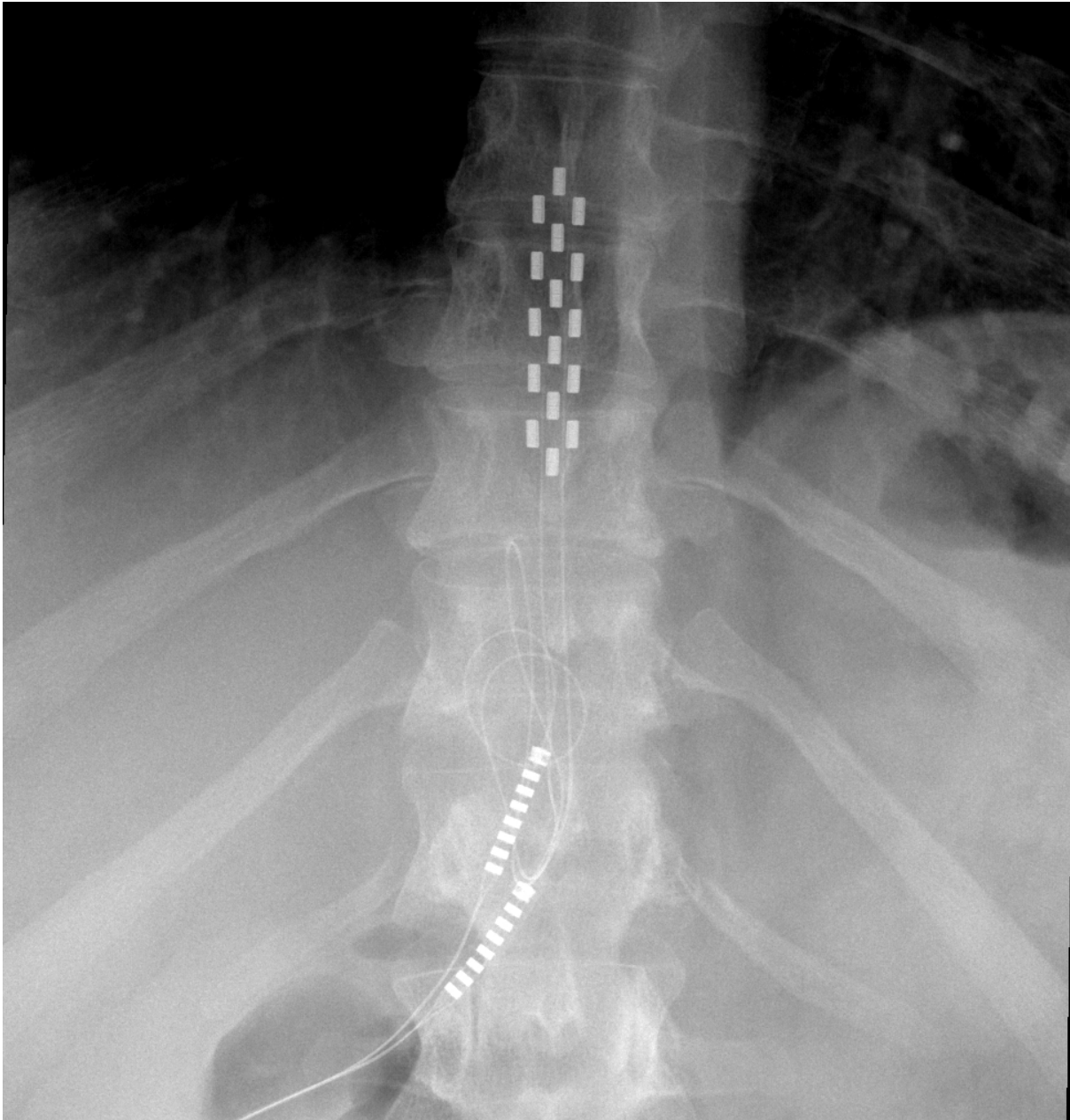

Anterior view X-ray of a 16 electrode paddle lead implanted in the posterior epidural space of the thoracic spine.
https://commons.wikimedia.org/wiki/File:Anterior_thoracic_SCS.jpg

SCS Trial: SCS treatment is unusual in that it is one of the very few surgeries where a patient can “try before you buy.” During an SCS trial, percutaneous leads can be implanted via a large bore needle through the skin, with the pulse generator remaining outside the patient’s body. This allows the patient to experience the effect of SCS treatment prior to undergoing permanent implantation. The trial often lasts from 3-7 days, and if the patient does not benefit from the trial, the implantation surgery will not occur.

For many years, a successful trial was defined as being > 50% pain relief in the targeted body area. In one of the most rigorous scientific studies only 67% of patients referred for SCS trial achieved this level of analgesic effect, and thus did not qualify for implantation,²⁴ while in other studies over 90% of patients passed the trial.^{25,26} Note that outcome studies for SCS often focus on those who were implanted, but the trial may have pre-selected patients who were more responsive to treatment, possibly biasing the results. More recent guidelines recommended that the success of a trial be defined not only in terms of decreased pain, but also improved functioning and/or reduction of opioid use.^{27,28}

Lead placement with or without intraoperative patient feedback. The SCS leads should always be implanted where, based on anatomy, the stimulation has the best chance of intercepting the pain signals. However, careful anatomical placement cannot replace the feedback provided by the patient during the lead placement. This is due to the extreme variability of the nervous system that makes it very difficult to infer the quality of the stimulation without actual patient feedback. While not obtaining intraoperative patient feedback can expedite the procedure it increases substantially the risk that the electrode might not end up in the correct place. Using this intraoperative method, the lead positioning can then be adjusted based on patient feedback. As the ultimate goal of this procedure is the reduction of the patient's subjective pain experience, having the patient report what is experienced prior to surgical closing has significant advantages. This surgical method tends to take somewhat longer.

Spinal cord stimulation programming: SCS programming can create one or more program "channels" by a) activating some of the electrodes on the lead and assigning them to function as either cathodes or anodes, b) setting the frequency to be used, c) setting the pulse width (i.e. how long the pulse lasts), d) setting the amplitude or strength of the signal, and e) in other ways further focus or alter the signal. Once programming is complete, an external remote control device can cause the pulse generator to send the signals as programmed on each channel. After implantation, programming the pulse generators to produce the most beneficial signal can require many sessions over a number of weeks. The programming process commonly provides the patient with several SCS programs to select from.

Electrode contacts: Electrode contacts are the parts of a lead that deliver the electrical stimulation. These contacts can be programmed to be either cathodes or anodes, and the electric signal is transmitted from the negative cathode to the positive anode. Most leads have multiple electrode contacts, and they can be programmed in multiple configurations.²⁹ This programming activates a defined pattern of electrodes on the lead and causes the cathode to transmit a specified signal.

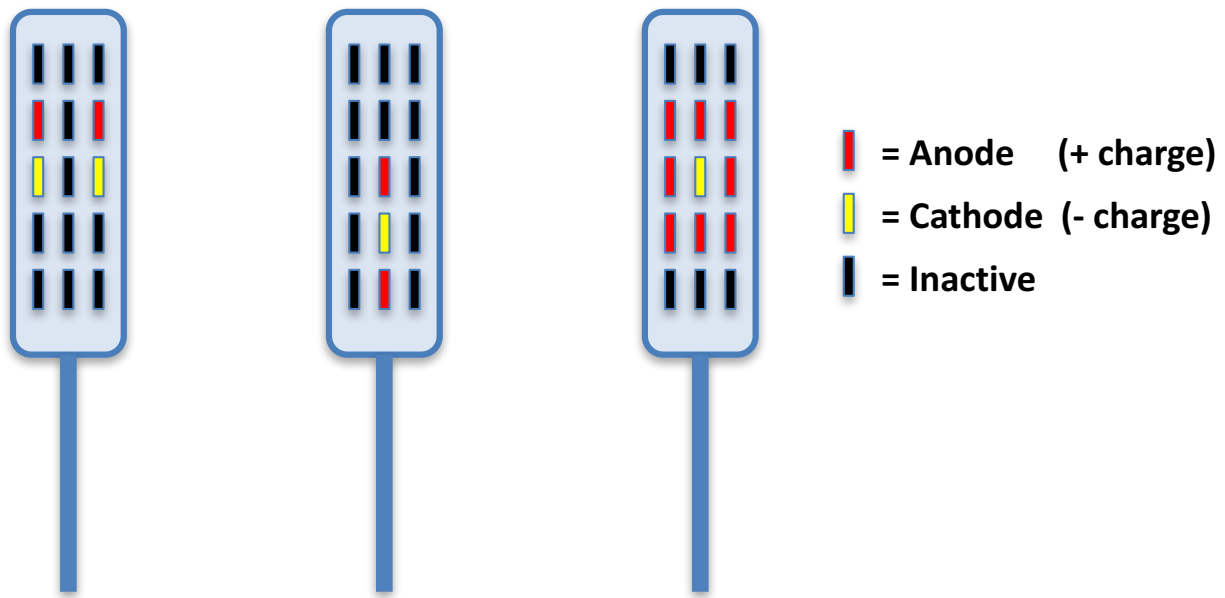

SCS Programming With Three Possible Anode/Cathode Configurations of A Paddle Lead
Graphic ©2017 by Daniel Bruns

Spinal Cord Stimulation Science

Evidence for SCS treatment: There is evidence that SCS is superior to re-operation and conventional medical management for severely disabled patients who have failed conventional treatment and have Complex Regional Pain Syndrome (CRPS I) ^{24,30,31}. A well-controlled scientific study compared SCS to conventional medical treatment (CMT), with CMT including an unspecified mixture of oral medications (i.e., opioids, nonsteroidal anti-inflammatory drugs, antidepressants, anticonvulsants, and other analgesic therapies), nerve blocks, epidural corticosteroids, physical and psychological rehabilitative therapy, and/or chiropractic care. This study found that SCS was better than conventional medical treatment at two-year followup.³¹

The most definitive longitudinal trial of SCS outcome compared SCS to six months of physical therapy (with the PT condition including optional PT follow-up care). This study determined that SCS plus PT was better than PT alone in the short term.²⁴ Subsequent follow-up found that this benefit persisted at two year follow-up³², but the benefits of SCS + PT were no longer greater than PT at five year follow-up.³³ Even so, at 5-year follow-up, despite the fact that 71% of the pulse generator implants had needed to be surgically replaced, 95% of the implanted patients said they would choose to do have SCS treatment again.³³ Note that due to improvements in battery and other technologies, the frequency of pulse generator replacement is likely to decrease. More recently, the conclusion of a trial of 10,000 Hz SCS was that 10K stimulation was superior to standard SCS at 12 and 24 months.^{25,26}

Historically most studies of SCS effects have focused on pain, while more recent outcome studies have looked more broadly at IMMPACT variables (see below).

Assessing SCS outcomes: Determining the outcome of SCS treatment is more complicated than one might guess upon first inspection. It has been noted in the literature that even trying to define what constitutes a good outcome for surgery or pain treatments is often problematic.³⁴

The first question that arises when trying to predict SCS outcome is “What do you mean by outcome?”

1. For decades the standard for successful SCS outcome was > 50% pain relief.⁴⁴ Unfortunately, there are a multitude of problems with that definition of success, as the > 50% pain relief criterion is perfectly arbitrary and has no empirical basis.
2. What constitutes a clinically significant level of pain reduction? It is worth noting that > 50% is more pain relief than is obtained from morphine (Maier 2002; Khoromi 2007). Farrar’s 2003 empirical study would suggest 33% pain reduction is clinically significant.³⁵
3. The > 50% pain relief criterion is often disregarded. If in the trial the patient says, “My pain dropped from a 10 to a 5,” in our experience the physician is unlikely to say “That

was a 50% drop. Needed 51% or more. Sorry.” Similarly, while that pain that drops from a 9 to a 5 is only a 44% drop, physicians may say the patient passed the trial.

4. Patients disregard this rule too. Patients are often informed that to pass the trial they need > 50% pain relief. As a result, a patient is highly unlikely to say, “I wanted that stimulator so bad, but had to admit that I only had 49% pain relief. DAMMIT!!!” Many patients have so much hope and effort invested in getting SCS that it would be hard for them to say “I failed the trial.”
5. What are the alternatives? Recent pain guidelines recommend that pain NOT be used to assess a SCS trial, but rather behavior.^{28,36} On the trial can the patient cut back on opioids? Walk farther on a treadmill? Go back to work? This approach recommends that to pass an SCS trial there should be an improvement in functioning.
6. Another possible outcome measure is patient satisfaction, but this outcome measure has a dark side. Patient satisfaction measures can be administered with the hope of having all your patients give you 4 or 5 stars online. Good patient satisfaction ratings are also good for marketing, and so there are multiple potential sources of social bias.
7. Another potential outcome goal is for SCS to reduce opioid use. The problem is that a high opioid use is a risk factor for a poor surgical outcome³⁷, and surgery has not been shown to be an effective method for treating opioid dependence.³⁸
8. Another outcome complication is predicting pain relief where? Reduce leg pain? Back pain? SCS is more likely to relieve extremity as opposed to pain close to the axis of the spine.
9. Overall, consideration should be given to what is the hoped response to treatment?
10. In our own research, we tried to address the outcome problem by first creating a composite SCS outcome measure which incorporated pain, function, satisfaction with care, mood and sleep, and then tried to predict the composite outcome measure³⁹ (Bruns and Disorbio 2016). So composite measures might be a possible solution.
11. Clinically, for the individual patient we may ask “Why do you want an SCS? How would you answer this question: “If I had less pain, I would _____.” If the answer is “Go back to work as an oilfield roughneck”, we would inform the patient if that is not realistic given the patient’s medical condition. If the answer is “I want to be able to take the grand kids to the zoo”, we might suggest making going to the zoo part of the trial, to see if the SCS treatment actually did accomplish this.

Like all pain treatments SCS is utilized to reduce a patient’s pain. However, as pain is a subjective experience, we assess pain via self-report. This means that the goal of SCS treatment is to change verbal behavior, and make the patient say “My pain has decreased by more than

50%!"⁴⁴ The difficulty here is that a patient's subjective reports can be influenced by a wide range of psychosocial variables.

Another challenge associated with SCS outcome research is that since normal SCS produces a paresthesia, a "blinded" study is not possible: The paresthesia lets the patient know when the SCS pulse generator is operating, making a placebo control impossible. More recently though, as high frequency stimulators do not produce paresthesia, blinded studies are now possible. One recent well-controlled double-blinded study by Perruchoud and colleagues compared high frequency 5 kHz SCS to sham SCS, with sham SCS being delivered by an implanted pulse generator that was programmed to remain inert. This study found no significant benefit for high frequency SCS treatment over sham SCS.⁴² At the time of this writing, this is the only sham study in the literature, and will need to be replicated, especially as one recent article reviewed studies suggesting that SCS stimulation above 7 kHz may have a different effect on neuroanatomy than stimulation at a lower frequency. There are other potential considerations here though.

Importantly, it has been assumed that producing no paresthesia makes high frequency stimulation better than regular SCS, as the paresthesia could be annoying. However, it is possible that paresthesia could serve as a distraction, as distraction is a known pain coping strategy.⁴³ Could the annoying paresthesia be an effective treatment, as it distracts attention away from pain? Could a strong paresthesia also produce a stronger placebo effect, because you can feel the device's power? Conversely, since you cannot feel high frequency stimulation at all, could that produce a nocebo effect (negative placebo) as a patient could wonder if the pulse generator was still working?

SCS complications, adverse events and concerns: Since SCS treatment consists of a foreign body implanted for a span of years and perhaps decades, adverse events are inevitable, and these vary in degree from mild to severe.

SCS treatment has been associated with frequent adverse events, which vary in degree from mild to severe. One multicenter study of SCS summarized information on the prevalence of complications seen in 7 years of clinical data as available, without using any specified time frames for follow-up. This study reported that in 24% of cases SCS complications were severe enough that the stimulator needed to be removed, with an overall complication rate of 35%.⁴⁰ In two SCS treatment studies with two year follow-up, after two years SCS related complications rates rose to 45% of patients in one study³¹, and 64% of patients in the other.⁴¹ In a third two year follow-up, 31% of patients had undergone a device-related surgical revision,³² while in the five year follow-up study noted above 71% of the pulse generator implants had been replaced, with one patient requiring implantation of a pulse generator four times to achieve a beneficial effect.³³

Overall, these data suggest that among patients receiving SCS treatments, while mild to moderate adverse events are common, severe complications are not. Among the more common of serious complications is infection, which could lead to removal of the implanted

system. Additionally, the physical presence of the implanted device can cause discomfort, which may require surgical repositioning of the equipment to address. Lead migration is also a common complication of percutaneous lead placement, and it also might require a surgical repositioning.

A final limitation of SCS treatment is that the benefits of SCS may decrease with time, and there are no well-controlled scientific studies showing that SCS is superior to other medical treatments over a period of time greater than two years.²⁷

Patient selection: It is generally believed that careful patient selection for SCS will improve the outcomes. Because of that, most guidelines require a thorough medical and psychological assessment prior to SCS (see Part II).

SCS mechanism of action: How SCS produces its effects is not clear^{45,46}, and clinical studies of the neurophysiological effects of SCS are rare.⁴⁷ In contrast to the volume of SCS research on perceived pain, there is relatively little research on humans about how SCS affects peripheral or brain neural activity, neurotransmitter levels in the spine, brain blood flow, or the functioning of non-neural cells (e.g. glial cells in the spine which synthesize neurotransmitters) in humans suffering from chronic pain. Paradoxically, SCS treatment appears to have only limited if any direct effect on A- δ or C type nerve fibers that transmit nociceptive (“pain”) signals.⁴⁵ There are numerous hypotheses about how SCS produces an analgesic effect.

- **Polarization and mechanism of action:** The extent to which a nerve cell has an external positive charge. Like most cells, nerve cells have a positive charge externally and negative internally. When a nerve fires, a negative wave travels down the exterior of the axon. This change of the axon’s polarity from positive to negative is called “depolarization.” Normally, an axon fires in one direction only. However, SCS stimulation creates a negative wave impulse that travels away in BOTH directions at a high rate of speed.^{45,47} In an A- β nerve fiber this signal travels about 100 miles per hour.

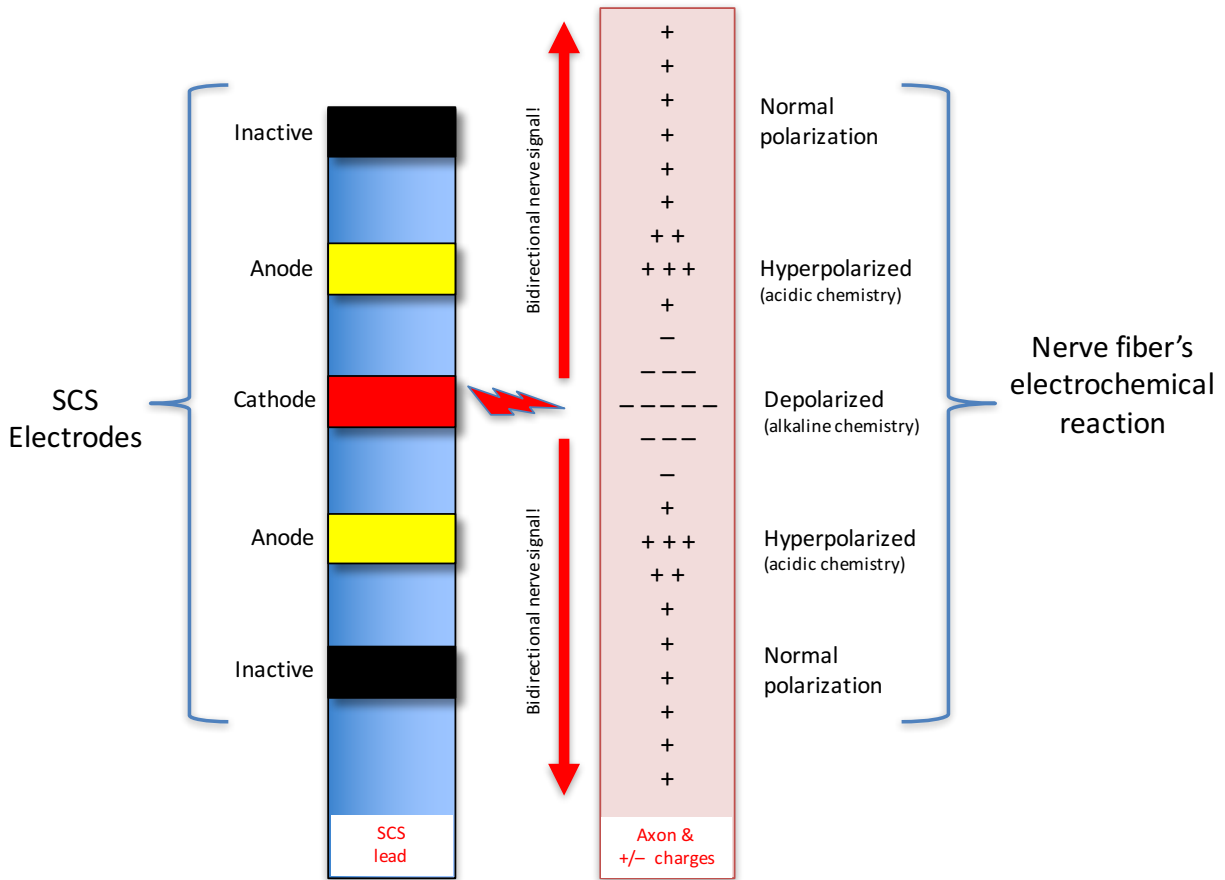

SCS signal produces both electrical and chemical changes in nerve fibers, and also produces a bidirectional signal in the nerve axons. Graphic ©2017 by Daniel Bruns, PsyD

- The original theory of SCS effect was based on gate control theory, and SCS treatment was thought to most strongly stimulate the large diameter A- β type nerve fibers. SCS has less ability to stimulate (alternately stated less ability to “recruit”) the smaller diameter nerve fibers of the A- δ or C types.^{45,47} It is the A- δ or C type nerves that conduct nociceptive signals.
- In addition to stimulating normal nerve signals, SCS also causes axons to “backfire”, and produce a signal traveling in the opposite of the normal direction (an “antidromic impulse”). These backfire signals can collide with nerve signals traveling in the normal direction (orthodromic), and block or “interfere” with them.^{45,47}

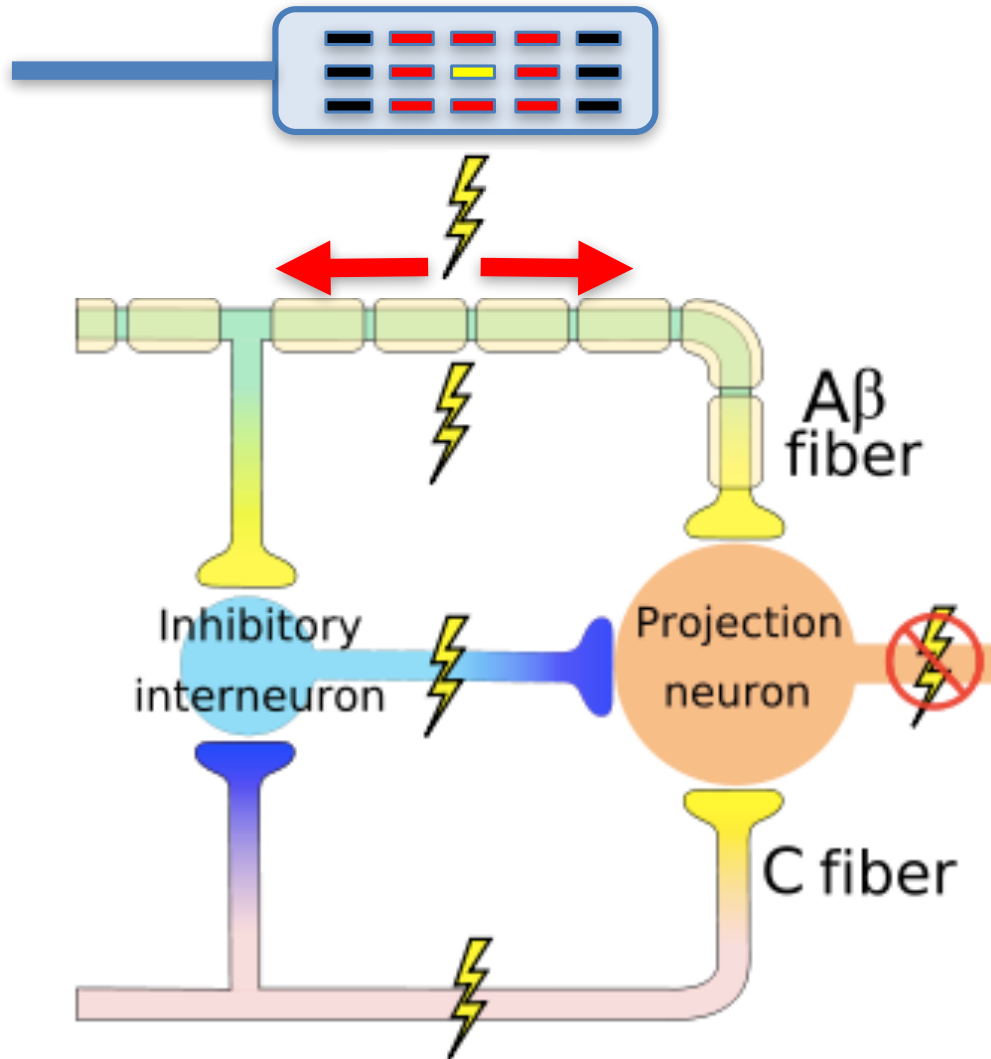

Theoretical explanation of SCS mechanism of action using gate control theory.
 Note induced bidirectional signal on the axon

Gate control image: self-made in Inkscape CC BY-SA 3.0,
<https://commons.wikimedia.org/w/index.php?curid=3542671>
 Adapted to show hypothesized SCS action by Daniel Bruns

- As both ascending and descending A-β nerve fibers can act in different ways to “close the pain gate”, this was the explanation used to explain SCS effects. Subsequent research however suggests that the effects of SCS are much more complex.^{45,46} Notably, in a number of important respects, the effects of SCS observed in the clinical setting are not what would be predicted by gate control theory. For example, gate control theory would predict that SCS would alleviate acute pain, but it does not.

- Lead type and electrode configuration determine the strength and direction of the signal that is “broadcast” by the cathode(s). Additionally, as spinal fluid conducts electricity, determining what tissues are being stimulated by SCS is a complex question that has been explored using mathematical modeling.⁴⁸
- Some studies have found that SCS may induce changes in the brain’s blood flow patterns and electrical activity.⁴⁹
- The propagation of an SCS signal through a nerve axon is often discussed as if it were the movement of an electron through a copper wire, but this is physically incorrect. The mechanism of action of SCS is also commonly discussed in purely electrical terms as well, but that may be incorrect as well. The transmission of a signal through an axon is actually the result of a complex electrochemical reaction.
- SCS places electrodes into spinal fluid, which is an ionizing chemical solution. A basic principle of chemistry is that if you place electrodes into an ionizing chemical solution and deliver current, it will induce chemical changes via electrolysis. Further, as SCS induces a negatively charged wave to travel through the axon, SCS can be conceptualized as producing a moving wave of electrochemical effects. The depolarization of a nerve fiber by SCS not only causes the surface of a neuron to change from a positive to a negative charge, it also causes a brief corresponding chemical shift from acidic to alkaline via electrolysis. In addition to neurons, glial cells in the spine also react to SCS signals.⁵⁰ Some studies have found that SCS chemically alters spinal functioning by increasing the level of certain neurotransmitters in spinal synapses (e.g. serotonin, norepinephrine, and GABA or gamma-amino butyric acid) that act to decrease pain, and suppressing glutamate, a neurotransmitter that acts to increase pain.⁵⁰ Thus, the effect of SCS may best be conceptualized as electrochemical.
- While axons are usually thought of as conducting electrical signals on their surface, in their interior axons also transport nutrients, neurotransmitters and other complex molecules through a nonelectrical conduction process called axonal transport. Some studies have found that neuropathic pain may be associated with disruptions in axonal transport.⁵¹ A search of SCS effects on axonal transport returned no studies.
- Studies have found that differing SCS frequencies, waveforms and amplitudes have the effect of producing varying sensory experiences.⁵² Despite the advances made by research, there remains a great deal that we do not know.⁵⁰

Why is paresthesia associated with pain relief?

The somatosensory nerve system is composed of two parts that are intertwined in the spine, the spinothalamic (pain) and the lemniscal (touch and movement) systems:

The spinothalamic system is composed of nerve fibers that transmit nociceptive signals which are associated with pain.⁴⁷

The lemniscal system is composed of nerve fibers that transmit signals pertaining to touch, vibration, pressure, and proprioception (position in space).⁴⁷ A central tenet of gate control theory is that these two systems compete with each other to send signals to the brain.

Gate control theory predicts that activation of the lemniscal system tends to “close the gate” on the spinothalamic system and to thus block pain signals.⁴⁷ Thus, moving or rubbing the injured area tends to block pain. Thus the soccer coach recommendation to “walk it off.”

The paresthesias of SCS are thought to be produced when SCS stimulates A-β sensory nerve fibers associated with the lemniscal system. Stimulation of these fibers creates a perception of tingling in the area of the body from which these nerve fibers originate.

The analgesic effects of SCS are thought to be partially produced by the stimulation of these same A-β sensory nerve fibers, as some of these also act as above to “close the gate” on the spinothalamic pain signals. That explains why the paresthesia predicts where the pain relief will be: Electrical stimulation of these lemniscal A-β fibers both produce paresthesia in a localized body area via the orthodromic signal, while closing the gate on intertwined nociceptive nerve fibers from the same body area via the antidromic “backfire” signal.⁴⁷

The analgesic effects of SCS are also thought to be produced when SCS stimulates descending nerve fibers that inhibit pain.⁴⁷

The fact that high frequency stimulation produces analgesia without paresthesia does not have a clear explanation under gate control theory.⁵⁰

How do SCS system outcomes compare?

One study compared 40, 500, 1200 Hz, tonic, burst and placebo stimulation. Patients in this study expressed no clear preference for SCS frequency or waveform type. However, individual patients expressed preferences.⁵³

Electronic Neuromodulation Concepts

Waveform (aka signal type): The shape of an electrical or sound wave. Waveforms can differ with regard to wave shape, frequency, and amplitude. Programmed SCS “channels” may contain different waveforms that produce differing sensations in the patient.⁵² Some studies have found that glial cells in the spine react differently to different wave forms.⁵⁰ SCS waveforms are as a rule far simpler than waveforms occurring in nature, such as in a Hoffmann wave (see glossary entry below) or music (0.1 seconds of Mozart illustrated). Although various waveforms have been studied, existing SCS utilizes monophasic square waveforms.

It may be helpful to compare electrical waveforms to other waveforms. A middle C musical note is a sound wave with the same frequency, regardless of whether the note is produced by a piano or a violin. The same note played by a violin versus a piano sound distinctly different. That is because even though the sound wave frequency is the same, the sound waves are shaped differently. Just like one type of sound may feel more soothing to you, one type of electronic waveform may feel more soothing to your central nervous system, and create greater symptom reduction. Different SCS “programs” may transmit different types of waveforms, and the waveform may be patented.

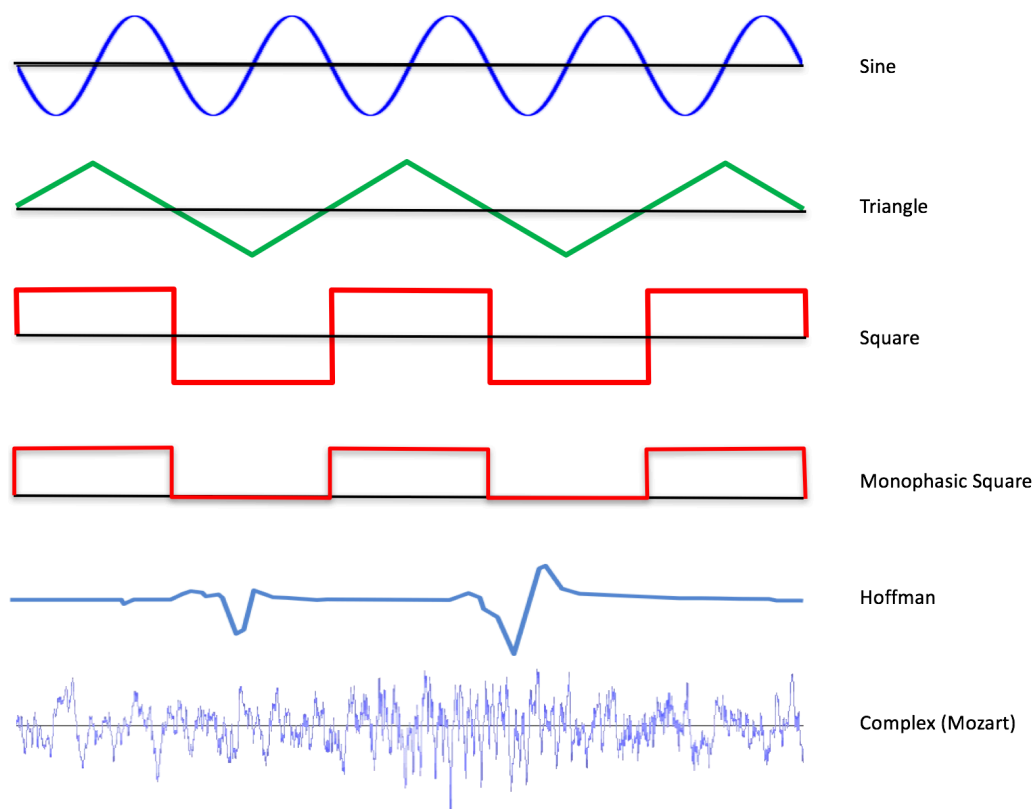

Types of wave shapes. Graphic © 2017 by Daniel Bruns

Hertz (Hz) and Amplitude (micro amps or μA): “Hertz” refers to the frequency of waves per second in a signal. Amplitude refers to the overall strength of the signal, and is measured in micro amps or μA . Note that increasing the amplitude and increasing the frequency of a signal both require more energy, and will drain the battery faster. On a radio, the tuning dial adjusts the radio to listen to a certain frequency of radio signal, while the volume dial increases the amplitude of the signal. In the human body, sensory nerves may transmit on a different frequency than motor nerves (e.g. H-waves), so it is possible to tune an SCS signal to match the therapeutic frequency of a target nerve.

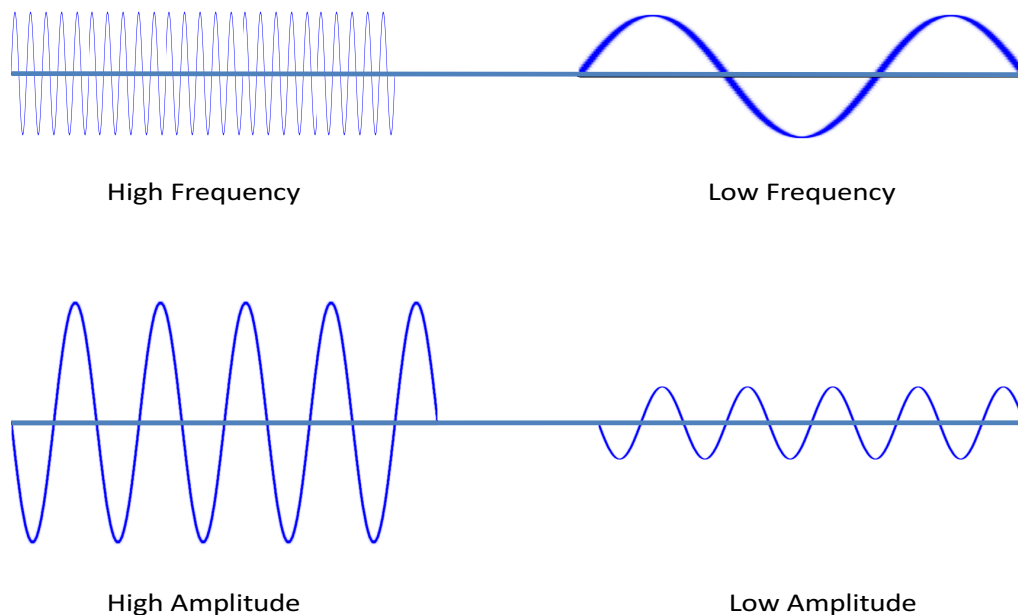

High frequency and high amplitude signals both contain more energy. Graphic © 2017 by Daniel Bruns

High frequency stimulation: High frequency stimulation is a newer form of spinal cord stimulation that utilizes a higher frequency signal. Whereas most SCS pulse generators create signals in the 40-60 Hz range, high frequency pulse generators can create a signal in the 1,000 to 10,000 Hz range. The advantage of high frequency stimulation is that at this higher frequency level, no paresthesia is created. To use a metaphor, high frequency stimulation could be likened to a dog whistle: high frequency stimulation is a powerful signal but the frequency is so high that it cannot be perceived by the human sensory system. The disadvantage of high frequency stimulation is that this requires much more energy to produce, and as a result the pulse generator will need to be recharged daily (vs. once a week). This creates a greater burden on the patient. Also, since battery life is rated based on the number of times the battery can be recharged, batteries may last a shorter time with this treatment, and replacing the battery requires surgery. There is no convincing evidence at this time that very high frequency stimulation is superior to lower frequencies.⁵³

Tonic stimulation: Tonic stimulation is the standard type of SCS treatment, where the waveform created by the pulse generator is being transmitted 100% of the time from the cathode to the anode.

Burst stimulation: A form of neuromodulation where the electrical neuromodulation signal is rapidly turned on and off producing “bursts” of stimulation. The “duty cycle” refers to the percent of time that the signal is “On,” and is usually expressed in a percentage. Thus, a duty cycle of 10% means the stimulation bursts are on 10% of the time, and 90% of the time no stimulation is occurring. Note that this is happening very rapidly, so a “burst” will only last for a small fraction of a second, followed by a similarly brief “rest” period. Some nerves (i.e. C fibers) are believed to operate in bursts, and may respond more strongly to this type of stimulation. As C fibers are anatomically associated with affective responses to pain, it has been hypothesized that burst stimulation may decrease pain-related suffering.⁵⁴ However, the advantages burst stimulation has yet to be clearly demonstrated.⁵³

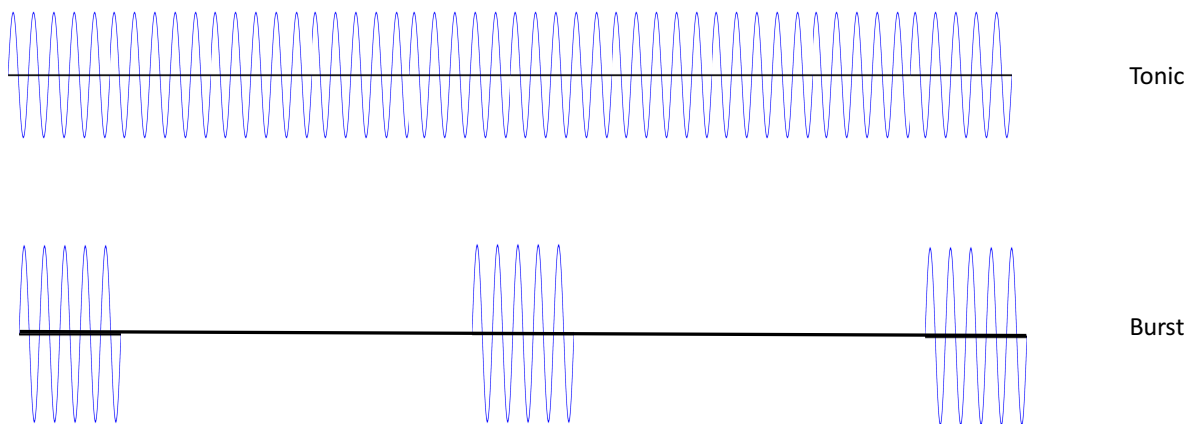

Graphic representation of tonic vs. burst stimulation. Graphic © 2017 by Daniel Bruns

Adaptive stimulation: A type of pulse generator programming that senses what the patient is doing (sleeping, active, etc.) and automatically changes the amplitude of the signal to the best level for that activity.

Wave interference: The “signal” created by an SCS pulse generator is an electromagnetic wave that can interfere with the transmission of nerve signals in different ways.

- When a nerve is electrically stimulated by SCS, the nerve responds by sending signals in both directions (i.e. both towards the brain and towards the periphery). One method by which SCS may work is that if an SCS signal could recruit a pain sensory axon, a wave traveling down the axon may block or interfere with a pain sensory signal traveling towards the brain.⁴⁷

When there are two or more cathodes, multiple wave patterns are broadcast. A basic principle in physics is that when wave patterns collide they interfere with each other, producing areas of stronger and weaker signals. As SCS may involve the use of multiple electrodes, complex interference patterns may be created.

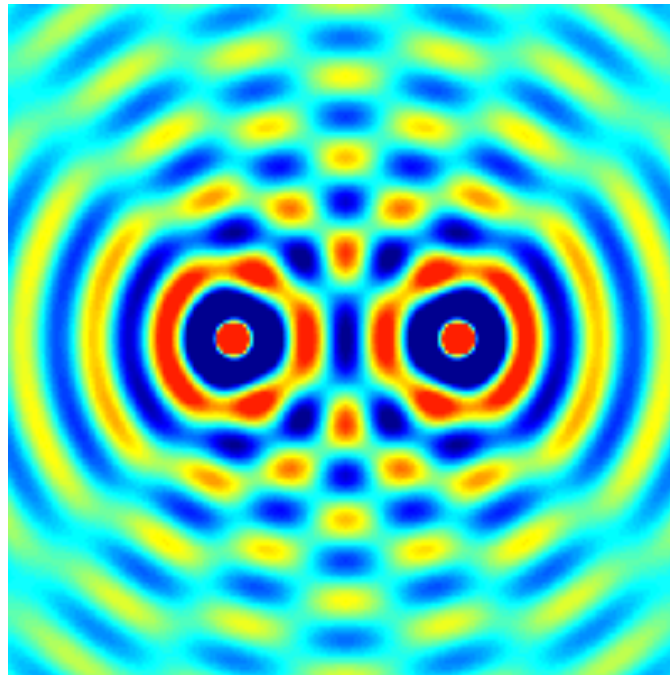

Animated demonstration of wave interference based on two wave sources

By Oleg Alexandrov [Public domain], via Wikimedia Commons

Click to see animation: https://commons.wikimedia.org/wiki/File:Two_sources_interference.gif

Which type of SCS is best? After all is said and done, a recent study showed no clear winner for SCS frequency or waveform type, although individual patients expressed preferences.⁵³ The “best” system may be the one that offers the widest range of options. This allows the patient to choose which type of stimulation to utilize, and clinical observations suggest that patient preference may vary over the course of a day.

If SCS signals were music, what would they look like? The electronics of SCS is hard to understand, but intuitively it may help to think of the signals like music. SCS signals are not music of course, but this analogy may help the reader understand the nature of the signals that the pulse generator generates. The 40hz signal of a standard SCS can be thought of as being like an E note on the bass clef, which is a sound with about 40 vibrations (sound waves) a second. The difference between various types of SCS signals would be something like this:

The Spinal Cord Stimulation Concerto
Music to soothe the CNS
Daniel Bruns, PsyD

$\text{♩} = 1000$

The image displays three musical staves, each representing a different SCS stimulation pattern. Each staff consists of a grand staff (treble and bass clefs). The first staff, labeled 'Tonic stimulation pattern', shows a bass clef with a single note on the E line (E2) and a dynamic marking of *f*. The second staff, labeled 'Burst stimulation pattern', shows a bass clef with a series of four eighth notes on the E line (E2) followed by a quarter rest, with a dynamic marking of *p*. The third staff, labeled 'High frequency tonic stimulation pattern', shows a bass clef with a series of four vertical lines on the E line (E2) followed by a quarter rest, with a dynamic marking of *f*. The tempo is indicated as $\text{♩} = 1000$.

Tonic stimulation pattern

Burst stimulation pattern

High frequency tonic stimulation pattern

Graphic © 2017 by Daniel Bruns

Surface Electrical/Magnetic Neuromodulation Therapies

Transcutaneous Electrical Nerve Stimulation (TENS): Transcutaneous means “across the skin.” TENS is a treatment that is similar in some respects to spinal cord stimulation, in that TENS employs a pulse generator that produces a signal in approximately the 40-100Hz ranges. However, the TENS electrodes are attached by adhesive externally to the skin, and are powered by an external pulse generator. Similar to SCS, TENS is believed to work by stimulating non-nociceptive fibers (see lemniscal system above) which blocks pain via the gate control theory.⁵⁵ One double-blinded, placebo-controlled study, found that low frequency TENS induces analgesia which can be detected on functional MRI with change in brain activity in multiple regions⁵⁶.

Transcranial magnetic stimulation (TMS): TMS treatment utilizes an electric coil held above the area of interest in the brain and uses strong magnetic field pulses to induce electrical currents in the brain. This is believed to stimulate the targeted brain area. TMS has been shown to have an effect on the pain threshold in healthy patients⁵⁷ and phantom limb pain.⁵⁸ Repeated transcranial magnetic stimulation (rTMS) has shown conflicting results⁵⁹, with one study showing no superiority over placebo.⁶⁰ A recent meta-analysis found that 5 sessions might result in one month of pain relief but that further studies were necessary.⁶¹

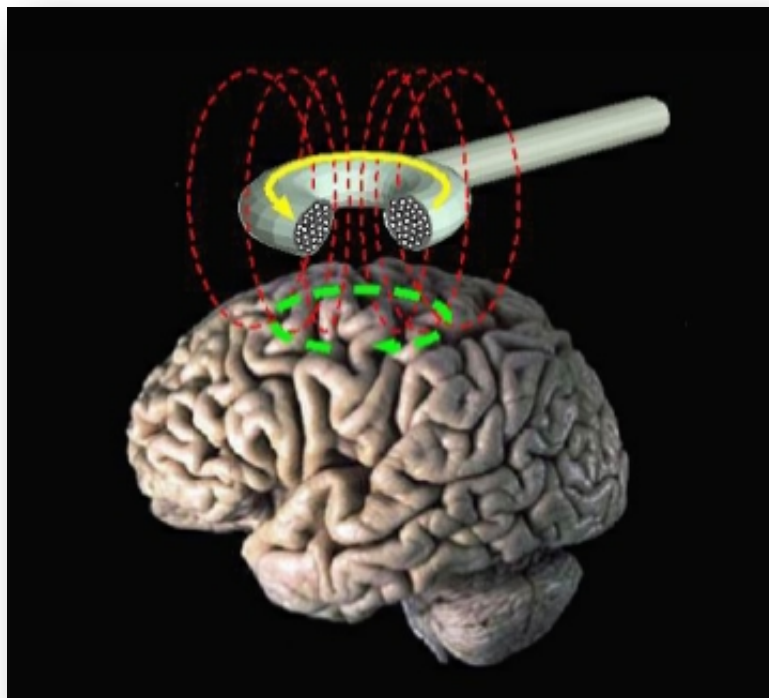

Transcranial magnetic stimulation

https://upload.wikimedia.org/wikipedia/commons/6/67/Transcranial_magnetic_stimulation.jpg

Spinal Cord Stimulation: Assessment Considerations

SCS is most commonly used for pain that radiates away from the spine, and especially into the arms and legs. (e.g., chronic regional pain syndrome or radiculopathy).⁶⁷ This use of SCS is supported by substantial evidence gained from clinical trials.^{68,69} It has been theorized that SCS acts within the spinal cord to interfere with pain sensory signals, and in so doing replaces the perception of pain with a paresthesia or tingling sensation. More recent research suggests that SCS also produces changes in the brain's blood flow patterns and electrical activity.⁴⁹

For decades the standard manner of assessing SCS outcome was that SCS was thought to be successful if pain reduction was $\geq 50\%$.⁷⁰ Currently though, the scientific standard for assessing the effectiveness of treatment for pain are summarized in the Initiative on Methods, Measurement, and Pain Assessment in Clinical Trials (IMMPACT). The IMMPACT study recommended that all scientific studies of spinal surgery used to reduce pain should assess five dimensions of medical treatment outcome: levels of pain, physical functioning, emotional functioning, patient satisfaction, and the presence of adverse symptoms.⁷¹ With regard to adverse events, one study reported that 24% of SCS recipients had the stimulator removed due to complications, with an overall complication rate of 35%.⁴⁰³⁹³⁸³⁷³⁶³⁴³⁴³⁴ In another study, SCS device complication rates rose to 45% after 24 months (12).³¹ Because of this, careful patient selection is indicated.

In the case of invasive pain treatments, psychological factors can be stronger predictors of outcome than medical imaging.⁷² SCS is a surgical treatment whose success is based on its ability to change the patient's verbal behavior. Since pain is a subjective psychological experience⁷³, changes in the patient's pain is based on changes in the patient's report. Thus, if as a result of SCS treatment a patient's pain reports change from an 8 to a 3, the procedure is judged to be a success. Obviously though, numerous psychosocial risk factors could impact a patient's subjective experience, or bias the patient's report of pain. This is important presurgically, as for example a severely depressed patient is unlikely to be happy with SCS outcome. Consequently, the great majority of medical regulations, treatment guidelines, and payer policy statements require presurgical psychological evaluations prior to SCS treatments in order to predict a poor response to SCS treatment.

A systematic review conducted by Celestin and colleagues determined that the psychosocial risk factors for a poor outcome from SCS were pain intensity, poor pain coping, longer time with pain, poor physical functioning, somatic complaints, depression, anxiety, job dissatisfaction, older age, and lower level of education.⁷⁴ This study paralleled the results of one performed by den Boer and colleagues, which found almost identical predictors of lumbar surgery outcome.⁷⁵

The weakness of Celestin and den Boer studies were that they were unable to evaluate a number of important variables due to gaps in the scientific literature. In general, due to the difficulties involved in studying the effects of severe psychopathology on surgical outcome, scientific studies are difficult if not impossible. To address this, we published a study that reviewed both the empirical literature and expert consensus statements.⁷⁶ In addition to the

risk factors identified by Celestin, this study also identified a strong expert consensus for other risk factors including substance abuse, dangerousness to self and others, trauma, personality disorder, and other variables that are difficult to study.

In a subsequent test of this model, empirical and expert consensus variables were incorporated into a theoretical model called the Vortex Paradigm (a graphical representation of biopsychosocial theory regarding why some patients enter a “downward spiral” and fail to recover). This model hypothesized that the outcome of spinal surgery for pain could be predicted in a manner similar to the way heart disease is predicted. That is, a multivariate equation based on age, cholesterol, blood pressure, blood glucose, sedentary lifestyle, body mass index, genetics, and other variables could be used to predict heart disease. Parallel to this, the Vortex Paradigm would predict that a patient’s response to spinal surgery could be predicted by a multivariate equation that includes pain intensity, widespread pain, nonadaptive coping (e.g. catastrophizing or kinesiophobia), opioid dependence, conflicted patient-physician relationship, job dissatisfaction, depression, anxiety, childhood trauma, litigating for pain and suffering, etc. This model was then tested on multiple patient groups (spinal surgery, nonspinal surgery, acute injury, chronic pain, worker compensation, injury litigants, and brain injury) and was found to be associated with subjective dissatisfaction with care, and an objective implication of disability: unemployment.⁷⁶ These findings supported the model.

Due to the growing literature on presurgical psychological assessment, numerous medical treatment guidelines advocate psychological evaluations prior to a number of spinal surgeries and pain treatment, and for patients with chronic pain generally. A number of guidelines have referenced the vortex model^{68,69}, and further recommend that these evaluations should include reviewing the patient’s history, interviewing the patient about psychiatric risk factors, and administering standardized psychometric assessments.^{68,69} Additionally, psychological testing protocols for SCS presurgical psychological evaluations have been described in the clinical literature⁷⁷, and the relevant clinical and forensic standards for these assessments have also been reviewed.⁷⁸ Importantly, some of these protocols have been shown to have no indication of race or gender bias.^{39,76}

With regard to psychological evaluations specific surgeries, we know of no empirical or theoretical studies suggesting that any of the variants of SCS or spinal surgery (spinal cord stimulation, peripheral nerve stimulation, spinal fusion etc.), have unique psychosocial predictors of outcome.[†] To the contrary, it appears that the Vortex risk factors appear to be broadly predictive of a poor outcome from medical treatments generally.⁷⁶

In contrast, there *is* research suggesting that regarding medical outcome from lumbar surgery, psychosocial predictors of decreased pain⁷⁹ differ from predictors of improvement in function,⁷⁹ and these differ from predictors of opioid craving.³⁹ Thus the only differences in psychosocial predictors that have been reliably demonstrated are associated with what predicts a particular *type of outcome, not a particular surgery type.*

[†] The one exception to this may be presurgical evaluation for morphine pumps, where addictive tendencies may increase the risk for mortality (see section on IDDS).

Finally, when performing these evaluations, it is important to remember that virtually every patient with chronic pain has some psychosocial risk factors. This makes it important to have appropriate norms for a basis of comparison: Is this patient's risk level higher than that of the average patient? As psychometric signs of a poor outcome increase from high to extremely high there should be increasing caution about surgery and increasing consideration of conservative alternatives, especially when there are risk factors that are easily treated (e.g. insomnia).

Part III: Intrathecal Pumps

Chemical Neuromodulation Therapies

Intrathecal pump (aka morphine pump, baclofen pump): Implanted intrathecal pumps can deliver pharmacological agents such as analgesic or antispasmodic agents into the intrathecal sac that surrounds the spinal cord, thus modulating the activity of neurons in the spine.

Although “neuromodulation” generally is used to refer to electrical techniques, neurotransmitters such as dopamine, serotonin, acetylcholine, GABA and histamine also act to modulate the activity of the nervous system. Neurotransmitters are released by neurons, and the level of these neurotransmitters can be altered by various medications in the intrathecal space.

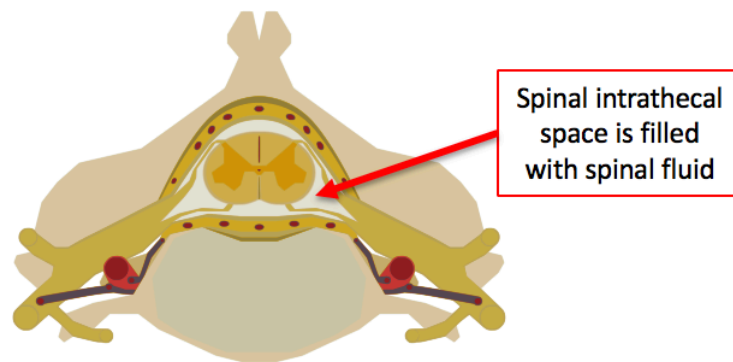

Intrathecal space: Also known as the subarachnoid space, the intrathecal space is a region surrounding the spinal cord which is defined by the arachnoid tissue layer. The Intrathecal space is filled with cerebrospinal fluid.

Intrathecal pump: An intrathecal pump can be used to deliver different medications into the intrathecal sac around the spinal cord. Most commonly, the medication is either an opioid for pain, or baclofen for spasticity due to spinal cord injury (see image below).

The use of intrathecal pumps allow medication to be given in smaller doses because it does not have to be absorbed through the intestines, like a drug taken orally, and then pass through the liver before circulating to the target area. By using an intrathecal pump the dose of the medication can be reduced by as much as 99% less than an oral dose and still have the same effect. Patients return periodically to have the drug reservoir refilled. This can mean fewer medication side effects, and improved quality of life. However, these devices have been associated with a concerning level of adverse events.

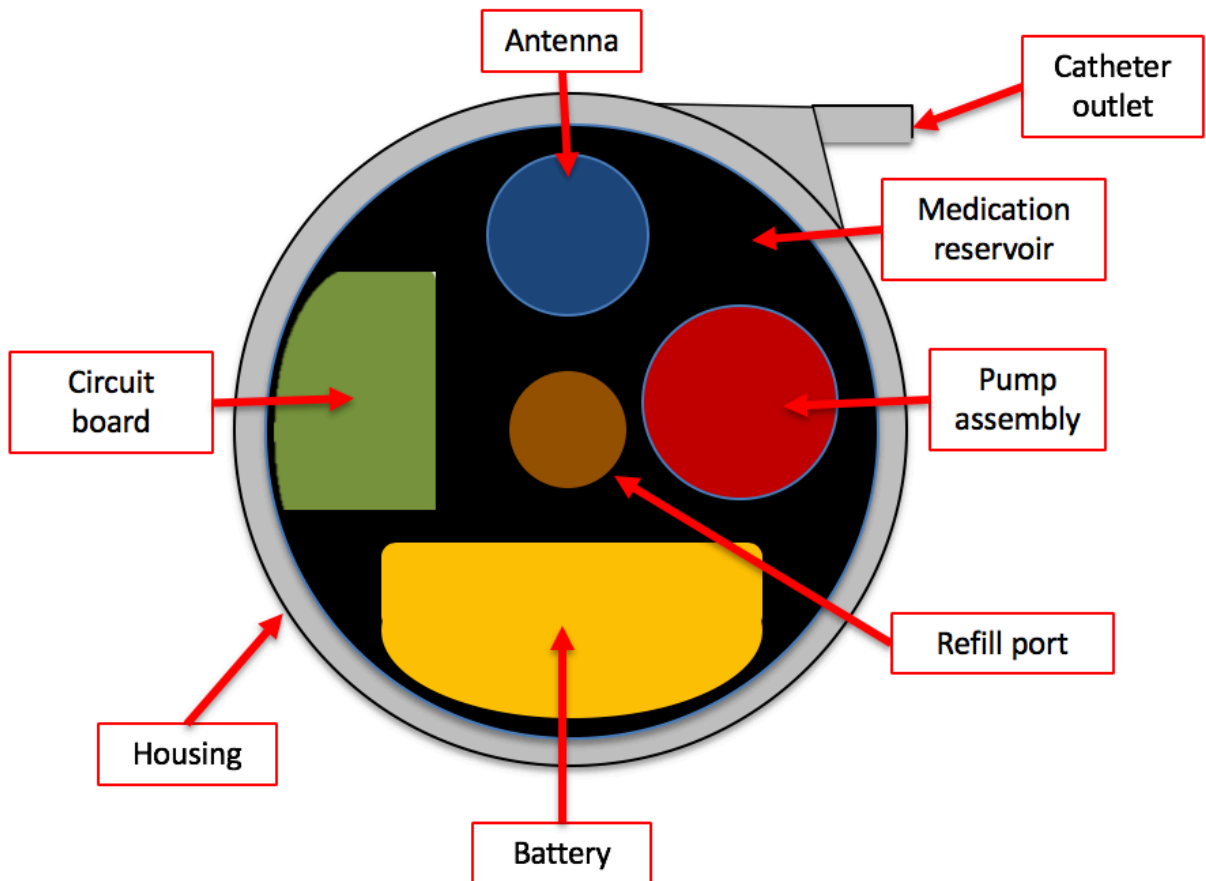

Intrathecal pump schematic. Image ©2018 by Daniel Bruns, PsyD

Rationale for intrathecal drug delivery systems (IDDS): Oral doses of analgesic medications are absorbed by the gastrointestinal system, and distributed indiscriminately throughout the body via the bloodstream. In contrast, IDDS allows the targeted delivery of analgesic or antispasmodic medications. The benefit of IDDS is that it allows for the use of a far smaller dose of medication, with estimates of benefits ranging from dosage reductions of 92% to over 99% (with recommended oral: intrathecal equivalency ratios ranging from 1:12 to 1:300).⁸⁰ It was reported in one review study that the doses of morphine used were 0.05-2mg a day,⁸¹ which is far lower than typical oral doses. In theory, this substantial dosage reduction would reduce the risk of adverse medication reactions.

IDDS and risk of mortality: Unfortunately, there are significant risks involved with IDDS, with an almost 4% mortality rate in the first year after starting or restarting treatment.⁸² The causes of death were multifactorial, and included:

1. Intrathecal morphine pumps are often used for the treatment of cancer pain, and some of the mortality is disease-related.

2. However, a substantial portion of the mortality appears to be related not to the patient's disease state, but rather to treatment variables. For example, if the patient is not carefully prepared, a patient may continue taking his/her usual dose of oral opioids (or other medications with the side effect of respiratory suppression) after starting IDDS. These two treatments concurrently increase the risk of overdose and death via respiratory depression.
3. Currently, there is no reliable method for determining the IDDS dose that is the equivalent to the oral medication dose.⁸⁰ This creates a risk of mortality due to erroneously programming the device to deliver a dose of medication that exceeds what is safe. This can also occur when the pump runs out of morphine, and the patient has been off of opioids for a period of time with a resultant loss of opioid tolerance. Refilling and restarting the pump under those circumstances without reprogramming the pump to administer lower opioid dose creates a risk of mortality.⁸³
4. There have been rare cases where mortality has resulted from a pump failure ("pump dump"), where several months of morphine is delivered in a single dose. While rare, this could result in immediate death.
5. IDDS also creates a risk of granuloma. Intrathecal pumps deliver morphine into the intrathecal sac through a catheter. This tends to produce inflammation at the tip of the catheter, and over time this can result in a mass called a granuloma. These can grow large enough to compromise the spinal cord and cause severe neurological disorders including paralysis. Research suggests that the prevalence of granulomas after 6 years exceeds 1%⁸⁴, and in one study the prevalence was 8.2%.⁸⁵ Additionally, other studies have found that the larger the opioid dose, the greater the risk over time.⁸⁶ This risk may be acceptable if the patient has terminal cancer and is not expected to have a long life span. But if you have a 30 year old patient with noncancer pain who may live another 40 years, the risk of granulomas increase over time, the risk becomes more concerning.
6. Other sources of morbidity include that the catheter may migrate to a new location, the catheter may break or become disconnected, a failing device battery can lead to unreliable performance of the device, insertion of the device can lead to infection or to a cerebrospinal fluid leak, and severe headaches also occur.⁸⁴ One study found that among those treated with IDDS, there was 3.7% risk of infection, a 0.9% risk of bleeding, and a 0.4% risk of neurologic injury.⁸⁷

Discussion: Intrathecal morphine pumps were initially used to treat cancer pain. If the patient only has 12 months to live you don't have to worry so much about long term risks, you just want the patient to be comfortable and have the best quality of life they can. The problem occurs when pumps are used long term for noncancer pain. If you disregard the risks, there is some evidence that IDDS can provide long-term relief in chronic non-cancer pain.⁸⁸

Guidelines are more variable regarding psychological assessment prior to pumps as opposed to stimulators. Many guidelines don't recommend psych evals for patients with cancer⁸⁹, as the long term risks may not be relevant for those patients, and generally psychological evaluations for baclofen pumps are not recommended either. In contrast, guidelines do recommend presurgical psychological evaluations prior to the use of intrathecal pumps for treating noncancer pain.^{28,36,89}

Presurgical psychological evaluations for IDDS are similar to SCS, with some notable exceptions. IDDS is associated with greater risk of morbidity and mortality than SCS. In the psychological evaluation of candidates for a morphine pump, the biggest risk for preventable mortality risk may come from the fact that morphine pumps are a "buzz kill." That is, through the use of IDDS technology, the opioid dose can be decreased as much as 99%, with an associated decrease in side effects. However, one of these side effects is opioid euphoria. If a patient is addicted to oral opioids, and is transitioned to a far lower dose on a pump, the patient may miss the opioid euphoria, and be tempted to take oral opioids in addition to what the pump is releasing. This creates a risk of overdose.

IDDS treatment could be looked at as creating an external locus for control for medications. If the patient has IDDS, and the patient is accustomed to taking a pain pill whenever s/he is feeling bad, the IDDS will ultimately determine the time and place of the dose. For example, Pre-IDDS, some patients have yo-yo doses. They may save their medications on good days, but then take substantially more medications on other days. This loss of perceived control may be difficult for some patients to accept, and so they may be tempted to take oral medication in addition to the IDDS.

Part IV: Presurgical Psychological Assessment For Spinal Surgery, Spinal Cord Stimulation, and Intrathecal Drug Delivery Systems

Companion Article: Bruns D, Disorbio JM. Q&A: Biopsychosocial Risk Factors for Spinal Cord Stimulation. *Pain Practitioner*. 2017; 27(3):19-22. Open access at http://bit.ly/SCS_QandA

Presurgical psychological assessment webinars and documents:

Visit www.healthpsych.com/scs.html for access to webinars and to download documents.

Visit YouTube channel at http://bit.ly/psych_webinars

Note: Links are case-sensitive

Spinal Surgery Treatments and the Biopsychosocial Model

Biomedical model: The biomedical model is that traditional medical model. This model regards physical health and mental health as being separate and distinct. Based on the biomedical model, pain is regarded as either being “real” or biologically based, or “in your head” and psychological in origin.

Biopsychosocial model: The biopsychosocial model is a more recent concept that was initially conceived as a new model for medicine. It was hoped that this new model could provide, “...a blueprint for research, a framework for teaching, and a design for action in the real world of health care”⁹⁰(p 129). In contrast to the traditional biomedical model, the biopsychosocial model provides a means of integrating the biological aspects disease and illness with its psychological and social aspects. The biopsychosocial model is the generally accepted model of pain, and is the model adopted by most evidence-based medical treatment guidelines.

Guidelines for spinal surgery: We have reviewed clinical and forensic guidelines for presurgical psychological assessments elsewhere.⁷⁸ Mandates for pre-spinal surgery psychological assessments are almost universal. These recommendations are based on scientific medical treatment guidelines such as those of the American College of Occupational and Environmental Medicine Pain Guidelines^{27,91}, the Colorado Medical Treatment Guidelines^{69,92}, and the Official Disability Guidelines.⁹³ Additionally, many other guidelines and payer policy statements have adopted these recommendations. For example, this includes requirements for pre-spinal surgery psychological assessments by payers such as the Centers for Medicare and Medicaid Services⁹⁴, BlueCross⁹⁵, Cigna⁹⁶ and United Healthcare⁹⁷, and state medical treatment guidelines such as those in California⁹⁸, Colorado^{69,92}, Connecticut⁹⁹, Delaware¹⁰⁰, Louisiana¹⁰¹, Minnesota¹⁰², Mississippi¹⁰³, Montana¹⁰⁴, New York¹⁰⁵, Oklahoma¹⁰⁶, Rhode Island¹⁰⁷, and West Virginia.¹⁰⁸ For example, the Centers for Medicare and Medicaid Services has the following policy about spinal cord stimulation treatments:

...Selection of patients for implantation of spinal cord stimulators is critical to success of this therapy...Patients must have undergone careful screening, assessment and diagnosis by a multidisciplinary team prior to implantation. Such screening must include psychological, as well as physical evaluation.⁹⁴

Practice Models of Presurgical Psychological Assessments for Spinal Surgery for Pain

Model I: Psychological clearance for spinal surgery: The phrase “obtaining psychological clearance for surgery” is a phrase sometimes used to describe a method of involving psychologists in the assessment of candidates for spinal surgery for pain. However, we do not recommend this practice model for the following reasons:

1. The psychological clearance model places the psychologist in the unusual position of being able to overrule a surgeon’s recommendations. Under this model, if a surgeon or interventional pain medicine physician recommends spinal surgery or certain other invasive procedures, the physician must then obtain approval or “clearance” from a psychologist before proceeding.
2. The origin of the “clearance” practice model can be traced to two medical consensus papers. The first of these was a consensus paper authored by Gybels and colleagues in 1998¹⁰⁹ which very briefly mentioned this matter. The second consensus paper by Beltrutti and colleagues in 2004 discussed this in much greater detail.¹¹⁰ In a nutshell, these two papers recommended that patients suffering from severe psychopathology should be excluded from SCS treatment. Severe psychopathology was defined by Beltrutti as suicidality, homicidality, active psychosis, active drug addiction and similarly extreme conditions. It has been our impression that physicians in the field generally agree that they do not wish to perform elective invasive procedures on patients who are severely psychiatrically disturbed. Subsequent to Beltrutti’s paper however, other psychological assessment criteria for SCS have been proposed, and are reviewed elsewhere.⁷⁶ It should be noted that while the Beltrutti paper focused on extreme or “primary” psychological conditions, research on psychological risk factors for surgical outcome focus on less severe or “secondary” psychological risk factors.⁷⁴⁻⁷⁶
3. The clearance model was subsequently adopted by payers, who required psychological assessment to assure that spinal surgery candidates were “clear” of psychiatric complications that would prevent them from benefitting from or cooperating with this treatment. Without this clearance, the payer would not reimburse the spinal surgery. This in effect gave psychologists veto power over SCS and other elective surgeries.
4. Problems with the clearance model are several.
 - a. Under this model the psychologist often has no involvement in the treatment planning process. Once the physician recommends spinal surgery to the patient, the patient is sent to the psychologist for clearance. In some cases, the patient is sent for clearance after having passed an SCS trial, or after the surgery is already scheduled. In such cases, the psychologist’s was excluded from the surgical

decision making process, and all that is being asked is for the psychologist to say “yes” so as to gain permission for billing. Thus, in practice this model does not function as an interdisciplinary model, and is rather a variant of the biomedical model.

- b. Under the clearance model the physician and psychologist are not collaborating on developing and implementing a treatment plan. In fact, this model can sometimes create an adversarial role between these two professions, with the physician proposing surgery and the psychologist canceling it.
- c. This model may offend patients. The worst-case scenario is that, without assessing psychological factors, the physician makes a biomedical recommendation and tells the patient, “You are an excellent candidate for spinal surgery and we have scheduled the surgery. Your pain will be greatly reduced, and you can get your life back. However, your insurance company requires you to see a psychologist to prove that you are not crazy and that the pain is not in your head.” Presented in this way, the psychological evaluation is perceived as offensive and threatening. If the psychologist does recommend against the procedure, this communicates to the patient that while this is a treatment you need, you are not psychologically worthy of it. These pressures can incentivize the patient to bias his/her responses, and increases the risk of getting a non-valid profile on psychometrics or of appearing more “somatoform.” This method of referral is ultimately counterproductive for the referring physician, as it may increase the risk of a negative recommendation.
- d. Some have expressed the opinion that payers have adopted this method not out of any belief in the biopsychosocial model, but only as a “hurdle” to reduce the frequency of spinal surgery utilization. Others have expressed the opinion that payers took this step as treatments such as spinal surgery have sometimes been utilized excessively or inappropriately, that is, utilizing spinal surgery prior to other effective treatments that may be safer, more easily tolerated and less expensive.
- e. In order to meet payer requirements and allow patients to have access surgery, some pain practices hired psychologists to “clear” their patients. It has been noted by guidelines however that this creates a conflict of interest for the psychologist, as a “No” spinal surgery recommendation decreases the employer’s revenues. To avoid this conflict of interest, guidelines have recommended that the psychologist performing evaluations in this manner should not be employed by the facility supplying the surgical services.^{27,28}
- f. Overall, this model tends to not feel right to anyone: The surgeon does not like delegating the final authority to proceed with surgery to the psychologist, the psychologist may not like being excluded from treatment plan development, and

the patient feels the psychological evaluation is judgmental and threatening.

- g. Patients are sometimes referred to our clinic for “clearance” by physicians that we do not know. When that happens, we tell the patient our job is not to give a thumbs up or down about the proposed procedure, but to consider a range of treatments from which the patient might benefit and to make more general recommendations. Regardless of how patients are referred for our assessments, we use the guideline-based model described below.

Model II: Collaborative interdisciplinary assessment: We would advocate that the spinal surgery decision-making process follow the science-based “best practice model,” advocated by guidelines. Most simply, the guiding principle could be stated this way: Perform a comprehensive biopsychosocial assessment of the patient with the chronic condition, and then do the best thing.^{77,111,112} How can the best treatments be identified? The algorithm of scientific medical treatment guidelines generally evaluates treatments along the following lines.^{27,69} The next step in treatment is always to seek interventions that have stronger evidence of being:

1. effective for the patient’s condition
2. safe/have fewer adverse events
3. easily tolerated/lower patient burden
4. (as a tiebreaker) the less expensive alternative

If we “unpack” the above recommendations and consider them in greater detail in the context of surgery, how should surgical treatment decisions be made?

1. Perform comprehensive assessments of the patient’s medical (biological) condition and psychological condition. Also assess the relevant variables in the social environment.
2. The biopsychosocial team may include the patient’s primary care provider or not. If the PCP is not involved in the decision-making process, then a specialist such as a physiatrist, pain medicine physician or surgeon will need to gather and integrate information from the multidisciplinary team prior to developing a treatment plan.
3. Based on the biopsychosocial assessment, does the patient appear to be a good candidate for the proposed treatment?
4. Does the risk of adverse events associated with the proposed treatment outweigh the potential benefits?
5. Is the treatment easily tolerated, or is it burdensome to endure (e.g. period of high pain, high disability and long recovery time post lumbar fusion)? Does the burden imposed on

the patient by the treatment outweigh the potential benefits?

6. To what degree is the outcome of the medical treatment dependent on the patient's adherence to a demanding post-surgical treatment regimen (e.g. adherence to physical therapy post rotator cuff repair to avoid frozen shoulder)?
7. To what degree is the medical treatment being used to alter the patient's behavior or verbal report? For example, spinal surgery could be employed with the hope of facilitating behavioral change such as opioid cessation or return to work. Alternately, spinal surgery could be employed with the hope of inducing changes in the patient's verbal report, such as reports of reduced pain or satisfaction with outcome. To the extent that a surgical procedure is being used to alter physical or verbal behavior, the examination of behavioral variables is of great importance.
8. What are the alternative treatments? Is the proposed treatment the best one to offer the patient?
9. Among otherwise equal treatments, is one less costly? Would one treatment alternative create a financial burden or potentially bankrupt the patient?
10. Among otherwise equal treatments, what are the patient's preferences?
11. What is the professional's recommendation regarding the best thing to do? Decisions should be made by clinicians, not tests.

If we apply these rules to spinal surgery, there is evidence that spinal surgery treatment is an effective treatment for chronic pain, and that these benefits will last for a few years. However, adverse events are common with spinal surgery treatment, and available evidence suggests that its benefits may fade over time. If we review guidelines recommendations about SCS and cognitive behavioral therapy (CBT), there is stronger evidence that CBT is an effective treatment for chronic pain than there is for SCS^{28,36}, while CBT or CBT + physical therapy equaled spinal surgery outcomes in other studies.¹¹³⁻¹¹⁷ Additionally, CBT is not associated with adverse events, is low burden to the patient, and is far less expensive. Thus guideline protocols recommend CBT prior to SCS, because the evidence says that CBT would be the best treatment to offer.^{28,36} Alternately, if compared to lumbar fusion for chronic back pain, SCS would be more easily tolerated.

A "big data" study of 29 million patients over 15 years compared this evidence based biopsychosocial best practice model to usual care. The data from this study was consistent with the hypothesis that when compared to usual practice, this best practice model reduces disability and does so at less cost.¹¹⁸ This study is relevant as under a Federal law known as the Medicare Access and CHIP Reauthorization Act of 2015 (MACRA), healthcare payments systems are being developed where systems which produce good outcomes more efficiently are

financially rewarded, while systems that do not are penalized. At this time, the plan is for these rewards/penalties to make as much as an 18% difference in how much the healthcare system will be reimbursed. One of the authors (DB) has served as a technical expert for CMS regarding this incentive system, and it seems inevitable that these incentives will ultimately be applied to pain treatments generally. This would increase the financial incentives to use the biopsychosocial model.

Overall, a comprehensive biopsychosocial assessment of the patient helps to identify those patients for which spinal surgery is the best treatment. There is evidence that spinal surgery is effective for certain conditions, especially peripheral neuropathic pain. However, spinal surgery is not a cure for opioid addiction or pain preoccupation. When pain treatments that are more effective, easily tolerated, and have fewer adverse events have been exhausted, then spinal surgery is a treatment that can be explored. If the patient is then judged to be a good biological candidate for spinal surgery, and to not be at elevated psychosocial risk, then spinal surgery is a treatment that should be considered.

Spinal Surgery Psychological Assessment Concepts

Psychological Assessment For Spinal Surgery, Spinal Cord Stimulation, and Intrathecal Drug Delivery Systems: A very large review study concluded that in general, psychological tests are the scientific equivalent of medical tests.¹¹⁹ Consistent with the biopsychosocial model, psychosocial factors can sometimes be stronger predictors of the outcome of invasive pain treatments than can medical imaging.⁷² Guidelines recommend psychological assessments prior to spinal surgery for the purpose of patient selection. These assessments should include reviewing the patient's history, interviewing the patient about psychiatric risk factors, and administering standardized psychometric assessments.^{27,69} These assessments should follow the empirical and expert consensus literature for pre-stimulator psychological assessments.^{27,69,76} Additionally, protocols for presurgical psychological assessments have been described in the clinical literature⁷⁷, and the relevant clinical and forensic standards for these assessments have also been reviewed.⁷⁸

Primary presurgical risk factors (aka red flags or exclusionary risk factors): To apply the label "primary" to a risk factor indicates that it is so extreme as to by itself jeopardize the outcome of a medical treatment. In a prior study, after a review of the literature we concluded that there is a consensus among experts that primary biopsychosocial risk factors include dangerousness to self and others, psychosis, drug addiction, and other forms of severe psychopathology.⁷⁶ Primary risk factors range from uncommon to rare. However, out of a hundred patients, research suggests that several are likely to have one or more primary risk factor.³⁹ Primary risk factors are so disruptive that they are exceedingly difficult to study in medical trials (e.g. it is hard to imagine performing a surgical trial comparing a group of typical patients to a group of patients who were paranoid due to chronic methamphetamine intoxication). However, while randomized controlled trials are all but impossible with these populations, we have published multiple psychological assessment studies on patients with chronic pain who were reporting

primary risk factors. These have included studies of patients with chronic pain who were reporting suicidal ideation¹²⁰⁻¹²³, violent ideation¹²⁴⁻¹²⁷, suicide/homicide ideation¹²⁸, thoughts of killing a physician^{125,129}, and thoughts of suing a physician.^{130,131} The assessment of primary risk factors is important as RCTs routinely exclude patients with severe psychopathology, so there are no studies to suggest that spinal surgery works for this population.

Secondary presurgical risk factors (aka yellow flags or cautionary risk factors): Secondary biopsychosocial risk factors consist of ones such as moderate depression, anxiety or anger, pervasive pain, poor pain tolerance, catastrophizing, kinesiophobia, conflicts with physician, etc. Almost all studies of biopsychosocial risk factors for a poor medical treatment outcome are studies of secondary risk factors.⁷⁶ Two systematic reviews of psychosocial risk factors for a poor SCS/spinal surgery outcome have been published, which were conducted by den Boer and colleagues⁷⁵ and by Celestin and colleagues.⁷⁴ We subsequently reviewed these studies, and also reviewed expert opinions about these risk factors and were able to establish that evidence and opinion appear to be converging on a set of secondary risk factors.⁷⁶ We have also recently published multiple psychological assessment studies on patients with chronic pain who were reporting less well-researched secondary risk factors. These have included studies of secondary risk factors such as somatic symptom clusters^{132,133}, personality disorder¹³⁴, entitlement¹³⁵, and adverse childhood experiences.¹³⁶

IMMPACT variables: Defining what constitutes a good outcome from SCS or other pain-related surgery is problematic.³⁴ The standard in SCS trials has been that the trial is successful if pain reduction is $\geq 50\%$ ⁷⁰, but these standards have been evolving. The current standards for assessing the effectiveness of spinal surgery are published in a consensus statement called the Initiative on Methods, Measurement, and Pain Assessment in Clinical Trials (IMMPACT). The IMMPACT study recommended that all scientific studies of spinal surgery used to reduce pain should assess five dimensions of medical treatment outcome: pain intensity, physical functioning, emotional functioning, patient satisfaction, and adverse symptoms.⁷¹ The IMMPACT variables are all secondary risk factors.

Celestin / den Boer variables: The best available evidence about the psychosocial variables predicting SCS and spinal surgery outcome were identified by a systematic review conducted by Celestin and colleagues. These variables were pain intensity, poor pain coping, longer time with pain, poor physical functioning, somatic complaints, depression, anxiety, job dissatisfaction, older age, and lower level of education.⁷⁴ The Celestin variables are all secondary risk factors, and are virtually identical with the variables identified in a prior study of lumbar surgery outcome by den Boer and colleagues.⁷⁵

Nonadaptive coping styles: Nonadaptive coping styles are cognitive behaviors that can interfere with medical outcomes. Two such coping styles that have been shown to be particularly nonadaptive in a medical setting are catastrophizing (a tendency to exaggerate the severity of symptoms) and kinesiophobia (avoidance of activity out of fear of injury). Catastrophizing and kinesiophobia can sometimes be adaptive in the short term or in certain contexts. For example, it has been observed that catastrophizing can have social utility in that

catastrophized reports can be used to gain the attention and support of those who otherwise may be reluctant to do so.¹³⁷ Similarly, in the acute phase following an injury, some restriction of activity may be medically indicated. However, over the long term catastrophizing and kinesiophobia tend to impede recovery, and these two cognitive coping styles may interact.³⁹ Beyond catastrophizing and kinesiophobia though, there are a number of other psychosocial variables that may also interact. These are represented by the Vortex Paradigm.

Vortex Paradigm: A theoretical model of delayed recovery based on research about why some patients enter a “downward spiral” and don’t recover which considers a broader range of variables than does the Celestin/den Boer studies.¹³⁸⁻¹⁴⁰ It was the theory used to develop the BHI 2 test. The Vortex Paradigm conceptualizes intractable medical conditions such as chronic pain as resulting from a “downward spiral” caused by an interaction of biological, psychological and social variables which can collectively contribute to the onset of an injury or illness (see figure below). Once present, a biological condition may have both psychological and social consequences that may interact with the patient’s biological, psychological and social strengths and vulnerabilities. The Vortex Paradigm suggests numerous hypotheses that can be tested by multivariate methods. In a manner similar to the way heart disease can be predicted by a multivariate equation that includes cholesterol, age, blood pressure, diabetes, genetics etc., the Vortex Paradigm would predict that a response to medical treatment could be predicted by a multivariate equation that includes biological severity, mood, cognitive coping mechanisms, drug abuse, personality disorder, job dissatisfaction, psychological trauma, secondary gain, and other variables. The Vortex Paradigm includes both primary and secondary risk factors.⁷⁶ The Vortex Paradigm risk model was recently adopted by the ACOEM evidence-based treatment guideline for chronic pain²⁷, and was later also utilized to develop the MBMD’s presurgical risk assessment method.¹⁴¹

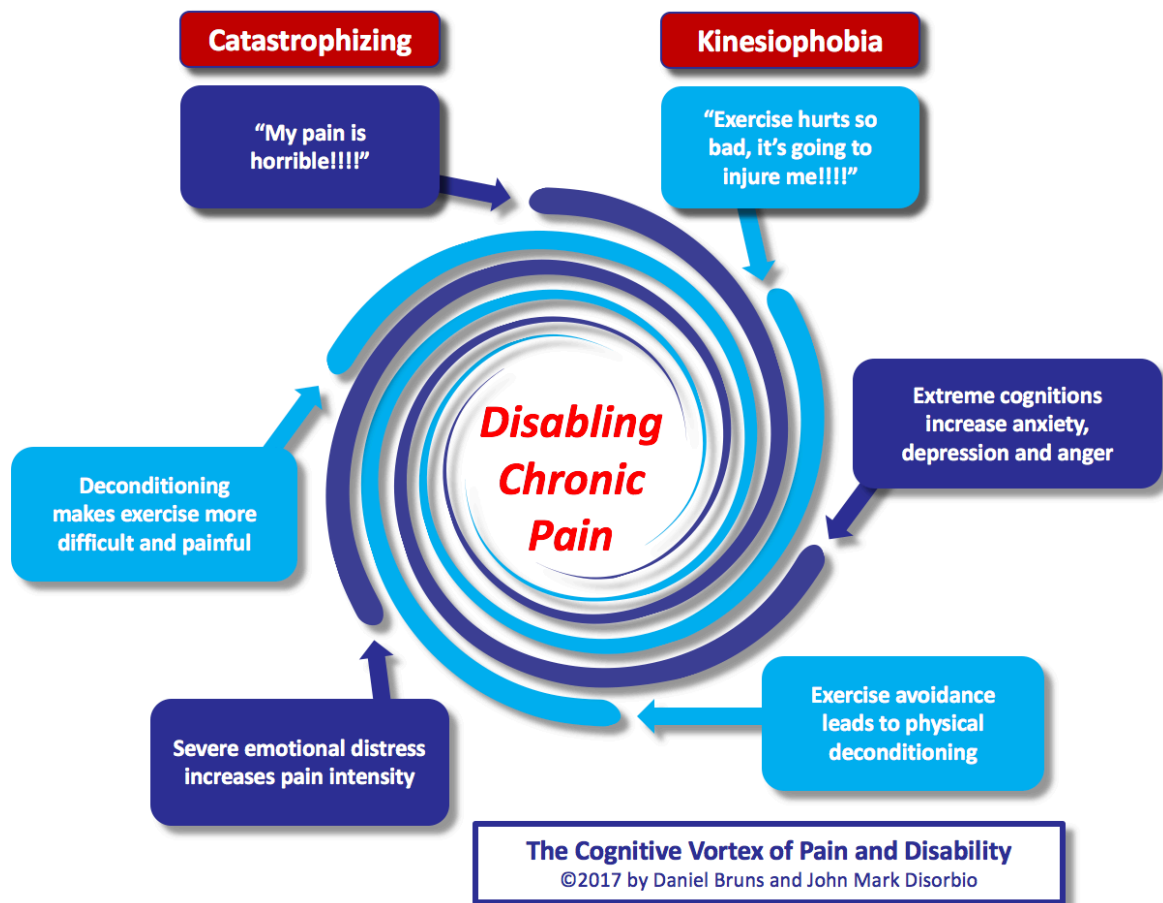

The cognitive vortex diagram illustrates how poor pain coping can result in increasing pain and disability, and cause a patient to enter a downward spiral. The cognitive vortex is a simplified version of the biopsychosocial vortex, which depicts a perfect storm of variables associated with a poor medical treatment outcome.

The Biopsychosocial Vortex

How intractable biopsychosocial disorders develop

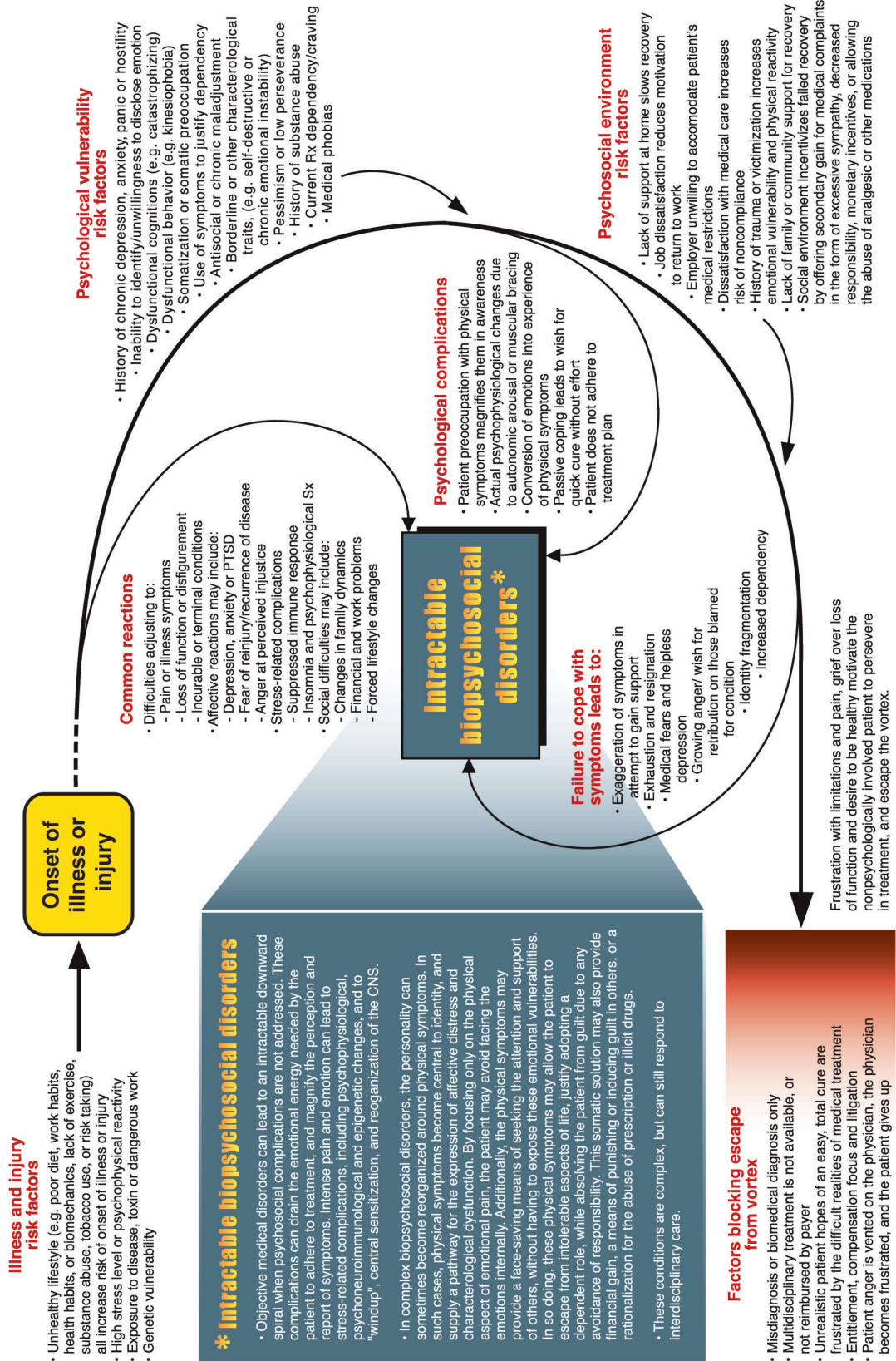

Biopsychosocial Vortex © 2016 by Daniel Bruns, PsyD and John Mark Disorbio, EdD. All Rights Reserved. Reprinted with permission.

BHI 2 Medical Intervention Risk Report Profile Graphic

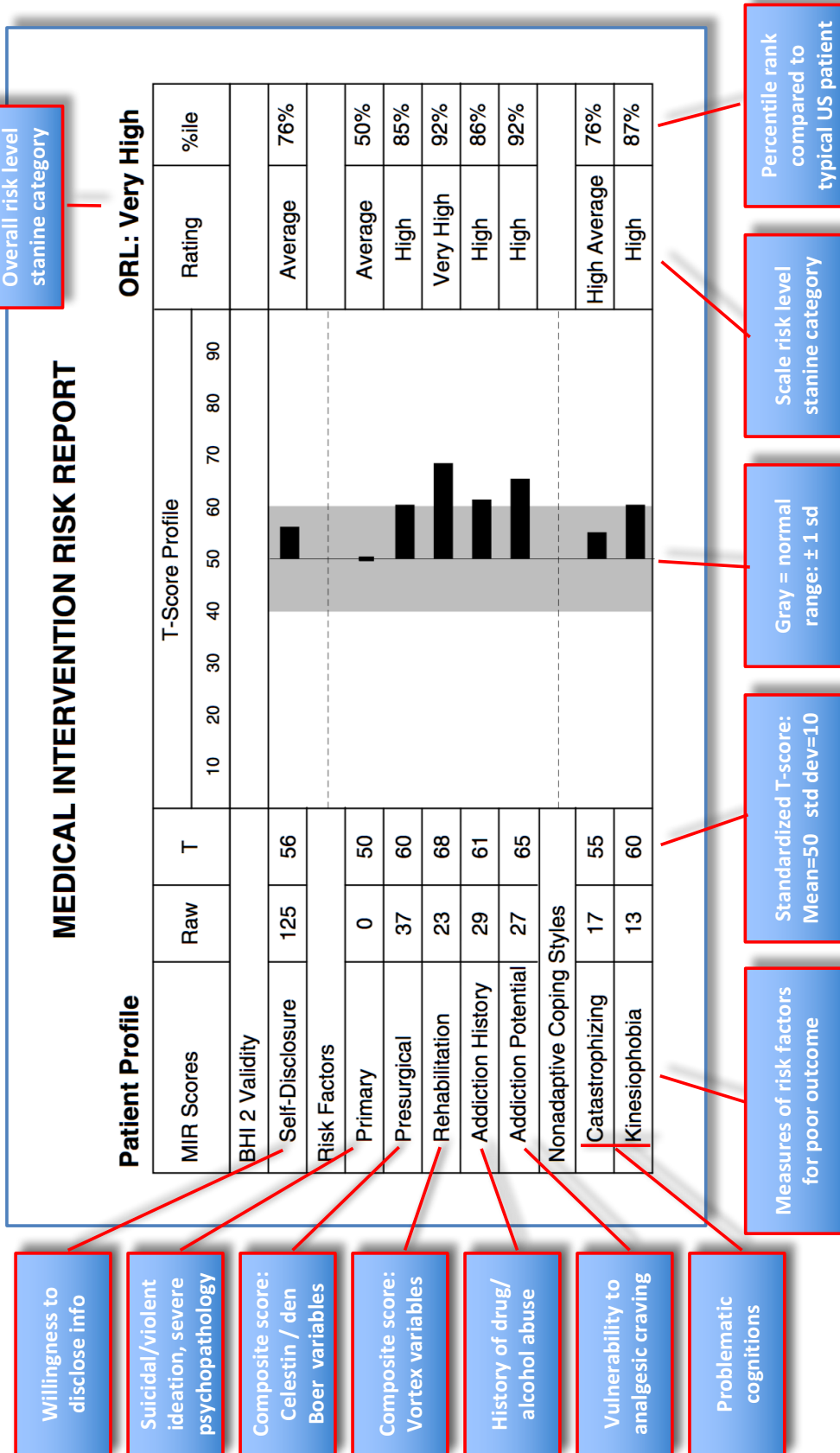

BHI 2 Medical Intervention Risk Report Profile Excerpt

© 2016 by Pearson Assessments. All rights reserved. Used with permission.

Battery for Health Improvement 2 (BHI2): A standardized biopsychosocial measure that assesses biological, psychological and social risk factors in medical patients.^{39,139,142} We developed this test and software system to assess patients being treated for painful medical conditions, and for performing pre-SCS and presurgical assessments. Its role in the assessment of chronic pain has been discussed in multiple guidelines and other documents.

27,44,69,77,93,101,104,106,112,138,139,143,144

BHI 2 Medical Intervention Risk Report (BHI 2 MIR): Computerized interpretation of Battery For Health Improvement 2 data that assesses a number of psychosocial risk factors relevant to spinal surgery outcome.¹³⁹ This includes the assessment of Celestin and Vortex risk factors for poor outcome from SCS and other medical treatments.³⁹ It assesses the following:

- **MIR Primary Risk Score:** A composite score based on the number of primary risk factors being present. These include dangerousness to self or others, and psychosis. It also includes any of various types of psychopathology (e.g. addiction, extreme dysfunctional cognitions, extreme conflicts with medical profession or risk of malpractice litigiousness) when they are present at a level above the 99th percentile in patients.³⁹
- **MIR Presurgical Risk Score:** A BHI 2 measure developed by first creating a composite IMMPACT variable score using a factor analytic method. This IMMPACT composite score was used as a measure of medical outcome, with a high score indicative of a poor outcome (high pain, high distress, poor functioning, low satisfaction, and adverse symptoms). Next, the Presurgical Risk Score was developed using a separate set of variables based on the Celestin/den Boer research. These variables were combined into a composite score which at cross-validation was a strong predictor of the IMMPACT composite score (ROC = .86).³⁹
- **MIR Rehabilitation Risk Score:** A composite score based on the number of Vortex secondary risk factors being present, with certain risk factors being weighted.^{76,77} This measure was developed based on the empirical and expert consensus literature on the psychological factors shown to predict the outcome of spinal surgery and spinal cord stimulation. In contrast to the Presurgical Risk Score and the Celestin/den Boer research, Rehabilitation Risk Score and the Vortex model considers a wider range of variables. For example, risk factors such as a history of psychological trauma, borderline personality, drug addiction and litigation for pain and suffering are not included in the Celestin/den Boer model, but nevertheless the expert consensus is that these variables are important risk factors.⁷⁶ The Rehabilitation Risk Score was found to be significantly associated with both work status and satisfaction with care for patients in multiple treatment groups (spinal surgery, upper extremity surgery, brain injury, work hardening, chronic pain, acute injury, and injured litigants).⁷⁶
- **Addiction History Risk score:** This score measures multiple historical risk factors associated with aberrant or otherwise problematic drug-taking behavior. This includes serious historical problems with drugs and alcohol, antisocial tendencies, and a history

of trauma.³⁹ Even if currently sober, patients with a history of addiction may be more vulnerable to becoming chemically dependent on prescription medications, especially opioids. This score is relevant to spinal surgery assessment as spinal surgery is sometimes used with the hope of decreasing opioid use. However, spinal surgery is not a treatment for addiction.

- **Addiction Potential Risk score:** This score measures a wide variety of currently existing pain-related risk factors associated with a craving for pain-relieving medications. This includes poor pain coping, distress, and distorted cognitions about pain and pain medications.³⁹ Craving can occur in the absence of addictive history, and in human studies, opioid craving has been shown to be associated with opioid abuse.¹⁴⁵ Medical patients with no prior history of addiction who begin to crave opioid medications as a result of their medical condition and treatment history are sometimes said to be suffering from “pseudoaddiction”
- **Catastrophizing:** A cognitive process whereby an individual greatly exaggerates the negative consequences of events or circumstance¹⁴⁶. Catastrophizing is associated with increased health-related anxiety^{57, 58} and depression.^{59, 60} With respect to pain behaviors, catastrophizing can adversely interfere with the coping behaviors of patients, disrupting the recovery process and increasing the risk for chronic pain.⁶¹⁻⁶³ Finally, catastrophizing has also been shown to lead to maladaptive behavior,⁶⁴ fatigue,⁶⁵ and suicidal ideation.⁶⁶
- **Kinesiophobia:** An “excessive, irrational and debilitating fear of physical movement and activity that results from a feeling of vulnerability in regard to a painful injury or reinjury”¹⁴⁷. In the acute phase following an injury or surgery, some restriction of activities is often medically indicated. In many cases though, recovery from a wide variety of medical conditions, including injury, chronic pain, heart disease and diabetes require physical activity. Some patients however may avoid physical activity out of an excessive fear that exercise will lead to pain or harm. The avoidance of activity resulting from excessive fears is not adaptive, and can lead to poor medical outcome.¹⁴⁸⁻¹⁵⁰ Kinesiophobia is closely related to the concept of the “fear-avoidance” of pain.

Outcome Risk Level (ORL): A MIR score that estimates a patient’s outcome risk level based on the overall MIR profile. The ORL identifies a patient’s most extreme of the three outcome-related risk factor (Primary, Presurgical, and Rehabilitation risk), as each captures a different aspect of outcome risk. The ORL rating is a verbal descriptor, but statistically is based on a “stanine” score (stanine = standardized nine category method). Stanine scores are a standardized psychometric method that place risk scores into nine categories based on the number of standard deviations from the mean patient score.[‡]

[‡] Standardized stanine scores on the MIR range from 1 to 9, and are associated with these descriptors and (approximate percentile ranks): 1=extremely low (1%), 2=very low (5%), 3=low (16%), 4=below average (35%), 5=average (50%), 6=above average (65%), 7=high (84%), 8=very high (95%), and 9=extremely high (99%).

Diagnosis and the Mind-Body Diagnostic Matrix

Although the term “biopsychosocial” is commonly used, how biological, psychological and social forces interact to alter states of health is rarely addressed. Over the course of the last century, disorders which exhibit prominent mental and medical aspects have been referred to alternately as mind-body disorders, endogenous psychiatric disorders, stress-related illness, hysteria, conversion, psychosomatic, psychophysiological, somatoform, somatizing, or somatic symptom disorders.

To understand the interaction between mental and medical disorders from the biopsychosocial perspective, one proposed classification system classified mind-body disorders into a 2x2 matrix.^{140,142} First of all, disorders were classified based on whether they were judged to originate primarily in biological processes (e.g. genetics, pathogens, toxins, abnormal biochemical processes, or physical injury) versus mental processes (e.g. perception, cognition, affect, memory or behavior). Secondly, disorders were classified based on whether the mind-body link appeared to involve a biological mechanism or a mental mechanism.

Using these definitions, endogenous mind-body disorders are believed to begin with biological processes, such as the onset of injury or disease. Here, biological processes produce an aberrant medical state, which directly alters brain functioning and in so doing produces psychological symptoms. For example, abnormally low levels of the thyroid hormone T3 can directly impact brain functioning in way that produces depression, and the etiology of this depressive state is independent of the patient's psychological processes. In this case, mood is lowered by a biological mechanism. Other examples of endogenous disorders include personality change secondary to traumatic brain injury or stroke, mood disorders secondary to endocrine dysfunction, or panic secondary to pheochromocytoma.

Reactive disorders are a second type of mind-body disorder, and occur when there is a psychological reaction to a biological state. For example, if a patient suffers a traumatic amputation of a finger, the *meaning* of this condition to the patient is determined by a psychological process that includes perception and cognition. This in turn could result a condition such as acute stress disorder. In this case, while the patient experienced an objective medical injury, there is no direct biological mechanism through which the severing of a finger produced acute stress disorder. Instead, the acute stress disorder results from how the patient construes the meaning of the injury. Thus, while in endogenous order, the psychological condition is caused directly by biological processes, in a reactive disorder psychological processes that produce the psychological symptoms. Examples of reactive disorders can include acute stress disorder, PTSD, adjustment disorders, major depression, and insomnia.

Psychophysiological disorders are a third type of mind-body disorder. Psychophysiological disorders originate with psychological processes, and produce objectively measurable medical symptoms. For example, a social phobia may originate with catastrophizing about the dangers associated with public speaking, and the resultant anxiety can precipitate a measurable organic

response, such as an elevated heart rate. Psychophysiological disorders may produce physical symptomatology through the autonomic nervous system (i.e. fight or flight response) or other mechanisms, and can produce objectively measurable medical symptoms such as palpable muscle tension, anxious tremors, hypertension, or fight or flight symptoms generally.

Finally, somatizing disorders are ones where psychological processes give rise to the perception or report of physical symptoms in the absence of any objective pathophysiology. For example, in the case of somatization, obsessive and distorted cognitions about the patient's own state of health may lead to an exaggerated perception of the importance of physical symptoms. Somatization may involve mistaken cognitive certainty that perceived symptoms are indications of a disease or injury, sometimes despite objective medical evidence to the contrary. Alternately, somatizing disorders may have a social basis, where symptoms are feigned due to an external reward or "secondary gain." In this later case psychological processes determine the report of physical symptoms, sometimes in the absence of any perception of symptoms. Alternately, somatizing disorders may involve internal primary gain (patient becomes subjectively convinced that s/he is sick to facilitate leaving job without having to admit failure) or social tertiary gain (patient feigns disability to stay at home and care for special needs child). Examples of somatizing disorders are somatization, illness anxiety disorder, or factitious disorders.

It should be noted that the mind-body disorders listed above are not mutually exclusive. Furthermore, traditional psychological diagnoses may fit into one category or the other depending on the particular manifestation of that condition. For example, the DSM 5 disorder somatic symptom disorder can be either a reactive disorder or a somatizing disorder, depending on whether the pathophysiology is real or perceived. Similarly, a conversion disorder could involve a mechanism that is an objective psychophysiological disorder (a syncopal conversion seizure), or is a somatized perception of a symptom that has no objective basis.

The value of the biopsychosocial model is that it provide methods of generating alternate hypotheses with regard to why some patients don't get better. These hypotheses can provide alternate methods of intervention for complex patients.

The Mind-Body Matrix

Mechanism of Mind-Body Connection	Origin of Disorder		
	Biological Processes	Psychological Processes	
Connection Between Physical and Mental Symptoms Accomplished Via a Biological Mechanism	Endogenous Psychological Disorders	Psychophysiological Disorders	
	Sample Types:	Depression due to hypothyroidism; personality change due to brain injury	Tension headaches, stress-related hypertension, irritable bowel syndrome
	Mechanism:	Illness or injury has direct effect on brain processes involving emotion, cognition, or personality	Stress-related chronic autonomic arousal or unhealthy behaviors lead to measurable organic changes
	Example:	Patient becomes short-tempered and impulsive due to brain injury	Autonomic arousal leads to palpable muscle tension and to chronic muscle pain; autonomic arousal and functional gastric pain
	Psychological Treatment:	Psychological support, disease management, compensatory strategies, address lifestyle changes (e.g., diet, exercise, smoking cessation)	Stress management, biofeedback, relaxation training, behavioral treatment to reduce distress and make lifestyle changes (e.g., work habits, exercise)
	Medical Treatment:	Appropriate medical treatment for illness/injury, medication as needed for depression or anxiety, or to stabilize central nervous system	Medications (e.g., anxiolytics, antidepressants, muscle relaxants or beta blockers) to interrupt the “fight or flight” response
Connection Between Physical and Mental Symptoms Accomplished Via a Psychological Mechanism	Reactive Psychological Disorders	Somatizing Disorders	
	Sample Types:	Injury or illness with reactive depression	Somatic symptom disorders, somatization, conversion disorders, factitious disorders
	Mechanism:	Emotional reaction to an objective organic problem	Misperception of or exaggerated report of physical symptoms that can be psychologically but not biologically explained.
	Example:	Patient suffers a disabling injury and reacts with depression; Patient is diagnosed with a terminal condition and has an anxiety attack	Unrecognized severe anxiety manifests with palpitations, and is perceived as a cardiac condition; symptom magnification to gain disability status
	Psychological Treatment:	Psychological support, address anxiety, depression, symptom management, facilitate lifestyle changes (e.g., diet, exercise, smoking cessation)	Psychotherapy to address underlying somatized concerns, psychological management of primary, secondary or tertiary gain
	Medical Treatment:	Appropriate medical treatment for illness/injury, medication as needed for reactive depression or anxiety	Medication for any underlying and somatized depression or anxiety

Spinal Surgery Psychological Assessment Methods

1. First of all, clinical and forensic standards for presurgical psychological assessment have been reviewed elsewhere.⁷⁸
2. The pre-SCS/pre-surgical psychological assessment is composed of several parts. These are:
 - a. Review of the medical records (what is this patient's medical condition, what treatments are being considered and why was this patient referred?).
 - b. Psychological interview of the patient
 - c. Psychometric assessment of the patient
3. If the psychologist does not review the medical records, this increases the risk the psychologist will be using the biomedical model, which divides the patient's treatment into medical and psychological silos. Knowing the medical context helps the psychologist to be a better member of the team.
4. The psychological interview of the patient should include gathering information about the patient's history, including medical, psychological, developmental, educational, marital, legal, vocational and other aspects of the patient's history. Some guidelines and texts describe recommendations for these interviews in considerable detail.^{28,77}
5. Guidelines suggest that the psychometric assessment focus on Celestin/den Boer variables²⁸ and/or the vortex paradigm²⁷.
6. Part of the assessment should include exploring the patient's thoughts and feelings about the proposed medical procedure. These are procedure-specific questions that are not part of the standard psychological assessment, and are not amenable to assessment by questionnaire. For example, questions to consider during an SCS presurgical psychological evaluation are as follows:
 - a. Sometimes the SCS trial is unsuccessful. Would you like to have a "Plan B"?
 - b. SCS is considered successful if it reduces pain by half or more. How would you feel if it only reduced your pain by half? How will you cope with the other half of the pain?
 - c. SCS often works for pain some distance away from the spine, but not well for

spinal pain. How would you feel if it did not reduce your spinal pain?

- d. More broadly, you report pain in five (or whatever) body areas, and the SCS will only address one or two of these. Will it still be worthwhile to go through this?
- e. How do you feel about having an implant inside your body (the pulse generator and leads)? How do you feel about having an *electrical device* inside your body?
Note: It helps to have a model pulse generator to show patients. If you do a lot of these, a medical device representative may be kind enough to give you a “dummy” model of one to show patients. If you don’t have one, the images on page 6 are actual size. If you cut the image out and paste it to a piece of cardboard about 3/8” thick you will have an approximate replica of the unit’s size.
- f. To the extent that the patient has a small frame, low BMI, good muscle tone, and prefers to wear form-fitting clothes, SCS can be disfiguring. This is because with this body type, the pulse generator will create a visible lump that can look something like having a can of chewing tobacco in your back pocket. This can be visible through form-fitting clothing. Alternately, SCS is less likely to be disfiguring in patients with larger frames and higher BMIs. However, as fatty tissue has less tensile strength, a pulse generator may be more likely to migrate to a different location through fatty tissue.
- g. Does the patient have difficulty operating his/her TV remote? The SCS pulse generator inside the patient’s body is operated by a remote-control device. If the patient has cognitive limitations, s/he may not be able to operate the SCS remote.
- h. Be aware that SCS will not make you feel normal. When it works, it replaces pain with a tingling paresthesia, which feels something like when your hand or foot goes to sleep.
- i. Be aware that SCS will not make you function normally. By itself, SCS will not increase your strength or range of motion. However, if you have less pain, you may be able to tolerate exercise better, and that can help to increase your strength or range of motion. But that will require exercising (and you will probably still have some pain).
- j. Be aware that SCS is not a cure for opioid dependence. Even if it could reduce your pain to zero, if you suddenly stopped your opioids you would be at risk for experiencing withdrawal.
- k. Be aware that there are potential alternative treatments that also might work (about the same/better/worse). Is SCS still on the top of your list?

- I. To the extent that the patient understands the risks, burdens and benefits of SCS, and chooses to do it, that patient is less likely to feel disappointed and dissatisfied with the outcome.
7. If a patient is at high risk for SCS treatment psychologically, that is not necessarily a permanent condition. For example, if the patient is having suicidal ideation, that should exclude the patient from SCS treatment at that time. That is because suicidal depression is a life-threatening condition, and treating a life-threatening condition takes priority over an elective procedure. If the patient's depression is successfully treated though, it would no longer be a risk factor for SCS.

Caveats

In the final analysis, to the extent that a medical treatment is judged necessary to preserve life or function, that biological necessity overrides psychosocial risk factors. If it is medically necessary to perform surgery on a patient who is psychologically at high risk (e.g. patient sustains a severe injury during a suicide attempt and requires surgery), a patient's psychosocial risk factor scores can be used to develop a psychological intervention perioperatively. However, to the extent a medical treatment is judged to be elective, is dependent on patient motivation to produce a good outcome, or is performed to produce a change in subjective symptoms (e.g. pain or patient satisfaction), psychosocial risk factor scores can play an important role in patient selection.

Conclusions

SCS is a complex treatment in that understanding how and when to offer it to a patient requires considerable knowledge. Important considerations for SCS include the biopsychosocial nature of chronic pain, surgical procedures associated with SCS, risk factors associated with SCS, adverse reactions to SCS, the electrical functioning of neurons, the neurochemistry of the central nervous system, electrical engineering, and psychological assessment. We hope that promoting a better understanding of these complexities will advance the cause of developing more comprehensive treatment plans for patients with chronic pain, and selecting the patients most likely to respond favorably to SCS and related treatments.

Risk, Medical Necessity And Recommended Treatment

Necessity of Medical Procedure

	Elective, for reduction of subjective symptoms	Indicated, not urgent	Necessary
Low/ Average Risk	Proceed with surgery as medically indicated after discussing alternative treatments	Proceed with surgery as medically indicated	Proceed with surgery as medically indicated
High Risk	Proceed with surgery only after exploring alternative treatments. Refer to pain psychology.	Interdisciplinary risk reduction prior to surgery is recommended. Refer to pain psychology.	Proceed with surgery using interdisciplinary perioperative treatment. Refer to pain psychology.
Very High/ Extreme Risk	Avoid surgery; exhaust alternative treatments. Intensive interdisciplinary risk reduction prior to any surgery is strongly recommended. Refer for behavioral treatment if severe psychiatric disturbance is present.	Delay surgery if possible until patient is psychologically stable. Refer for mental health treatment if severe psychiatric disturbance is present.	Proceed with surgery using intensive interdisciplinary perioperative treatment. Refer for mental health intervention if severe psychiatric disturbance is present.

Biopsychosocial

Risk Level

Part V: Q&A Post Presurgical Psychological Evaluation for SCS Webinar

The following questions were asked following a webinar on presurgical psychological evaluations for Spinal Cord Stimulation sponsored by Pearson Assessments. The questions and answers are organized by category below.

Click here to view webinar: http://bit.ly/SCS_psych_evals

Conducting the SCS Psych Eval and Forming Opinions

Q: If a patient with sciatica has longstanding neurotic issues, and the MD refuses to try SCS because patient is a pain to work with. Ideas? Annoying patients have pain that could be substantially improved by the SCS. The pain itself is making them more anxious and irritable. What to do?

A: This is an excellent and very challenging question. This question has been the subject of extensive debate when developing science-based medical treatment guidelines, such as the Colorado Chronic Pain Treatment Guidelines or the ACOEM/MDGuidelines Chronic Pain Treatment Guidelines. Both of these guidelines adopt what is called the “Best Practice Model.” That is, the goal of treatment is to always do the “best thing.” These guidelines would then define the “best thing” by looking at the following criteria:

- a) What treatments have the greatest evidence that they are effective?
- b) What treatments have the lowest risk of mortality or morbidity/side effects?
- c) What treatments place the lowest burden on the patient (i.e. is the treatment itself painful, or is the rehabilitation process long and difficult)?
- d) As a tie-breaker, for treatments that are otherwise equal on points a, b and c above, and are thus equally safe and effective, which is the least expensive?

Overall, the decision tree that most guidelines have decided upon involve trying to begin with treatments that are effective, but are low risk, low burden and lower in cost.

When the current guidelines review the science, it turns out that psychological treatments, such as CBT have greater evidence of efficacy than does spinal cord stimulation.^{27,28} On the other hand, spinal cord stimulation, while effective for many patients, has a very significant level of complications that occur over time.¹⁵¹ Additionally, patients who are high in “neuroticism” are at an increased risk for being unhappy with the SCS results in the long-term, so if it is possible to reduce those risks beforehand with treatments such as CBT, that would be desirable.

Q: For those that you put off to use other interventions first, when do you re-asses for SCS?

A: That is one of the most important determinations to make as part of a treatment plan coming out of the evaluation. In the case in the webinar of the woman with the gunshot wound, the goal first of all is to help her to be safe, and to get her feelings of terror under control. Those are tangible goals, although it is often difficult to specify how many weeks or months that might take. Note that on the MIR report, if the risk level is elevated, the report makes suggestions about treatments you could offer to reduce the risk level.

On the other hand, we have seen patients present for SCS treatment that had somatic delusions, who said things like, “You’d have pain too, if maggots were eating your spine.” Note that the patient had this medical belief despite multiple medical tests to the contrary. In this case, SCS is not a treatment for delusional pain and it is unlikely that the patient would ever be a candidate for SCS treatment.

Q: Do you assess cognition with these patients?

A: We can interpret this question two different ways, and so we will answer it both ways.

1. If SCS is being considered for an older person and dementia is suspected, we would recommend assessing the patient’s cognitive ability. That is because first of all, during a trial, a patient has to be able to reliably report changes in sensation produced by the SCS device. More importantly, following implantation, the spinal cord stimulator is operated by a remote. If a patient is unable to operate basic T.V. remote, they are probably unable to operate an SCS remote. This is important as it would be possible for a patient with dementia to turn the SCS device up to painful levels of stimulation and then be unable to turn it off. Thus, SCS is an unusual surgery, as it has certain cognitive requirements in order to operate a remote successfully.
2. This question could be interpreted with regard to whether or not the BHI 2 and MIR assess dysfunctional cognitions that could be targeted with treatment such as cognitive behavioral therapy. In that case, the BHI 2 assesses several types of dysfunctional cognitions. This includes catastrophizing, kinesiophobia, dysfunctional pain cognitions and dysfunctional somatic cognitions. Note that the BHI 2

catastrophizing scale is not a “pain catastrophizing scale.” That is because we decided that catastrophizing can be applied not only to pain, but to somatic symptoms and other concerns. Thus, elevations on both the catastrophizing and dysfunctional pain cognition scales would suggest pain catastrophizing, while elevations on the catastrophizing and dysfunctional somatic cognitions would suggest illness catastrophizing. Lastly, catastrophizing combined with kinesiophobia would suggest a patient catastrophizes about how badly he/she could be injured by exercises. All of those distorted cognitions could probably benefit from CBT.

Q: Do you make any categorical recommendations to surgeon? Yes with concerns, delays, etc.

A: There are some cautionary matters to consider when making categorical statements about surgery. They are as follows:

1. Sometimes there are scope-of-practice issues with regard to psychologists making categorical statements about appropriateness of a patient for surgery. While some surgeries are elective in nature and performed to alleviate subjective symptoms, in some cases there is a degree of surgical necessity. This matter is discussed in some detail in the BHI 2 MIR manual. For example, suppose a patient breaks his back during a suicide attempt and is suffering from *cauda equina* syndrome. On one hand, the patient is severely depressed and has primary risk factors in the form of being immanently suicidal. On the other hand, surgical necessity is present, as the patient is at risk for becoming a paraplegic if surgery is not performed in the near future. Thus, even though the patient may be at high risk psychologically, the surgical necessity in this case overrides psychological risk. In this case, the psychological risk factors will drive the post-surgical rehabilitation process. Thus, the psychologist performing these evaluations needs to remember that ultimately, the decision about whether or not ultimately to perform surgery rests in the hands of the surgeon, and that surgical necessity when present overrides psychological risk.
2. Presurgical psychological evaluations attempt to predict behavioral aspects of outcome such as will the patient be satisfied with care after the surgery, and will this treatment promote behavior change (e.g. reduction of opioid reduce and return to work)? To this extent, presurgical psychological evaluations can advise the surgeon with regard to whether or not this procedure is likely or unlikely to be successful. So, within that context, we might advise the surgeon that given the patient’s overall profile and risk factors, a patient might be extremely unlikely to be satisfied with the surgery. Even so, as above, sometimes there are biological reasons why surgery is necessary anyway. In many cases, we do suggest that if prior to SCS or surgery we could treat the patient’s depression, sleep disorder, distorted cognitions, etc., they would be more likely to respond favorably to the invasive treatment.

Q: I have completed SCS evaluations when working at a pain clinic. Are there panels that we can get on to conduct these SCS assessments?

A: With regard to Medicare, Medicare nationally requires presurgical psychological evaluations prior to spinal cord stimulation. So, if you are eligible to provide services under Medicare, you can provide those services to Medicare patients. With regard to Medicaid, we cannot advise you, as every state is different. In every locality that we know of though, where SCS is an offered service, presurgical psychological evaluations are required. You will need to explore services under Medicaid in your region, however.

With regard to private payers, with most private payers, such as Blue Cross, United Behavioral Health, and so on, reimbursement for presurgical psychological evaluations is being conducted through the mental health payer, more often than the medical payer. Thus, with regard to private payers, you will need to explore getting onto the mental health panels for reimbursement. Also, you should explore getting on the worker compensation insurance panels as well. Note that we have a separate white paper about getting on insurance panels.

We have reviewed clinical and forensic guidelines for presurgical psychological assessments elsewhere.⁷⁸ Mandates for pre-SCS psychological assessments are almost universal. These recommendations are based on scientific medical treatment guidelines such as those of the American College of Occupational and Environmental Medicine Pain Guidelines^{27,91}, the Colorado Medical Treatment Guidelines^{69,92}, and the Official Disability Guidelines.⁹³ Additionally, many other guidelines and payer policy statements have adopted these recommendations. For example, this includes requirements for pre-SCS psychological assessments by payers such as the Centers for Medicare and Medicaid Services⁹⁴, BlueCross⁹⁵, Cigna⁹⁶ and United Healthcare⁹⁷, and state medical treatment guidelines such as those in California⁹⁸, Colorado^{69,92}, Delaware¹⁰⁰, Louisiana¹⁰¹, Minnesota¹⁰², Mississippi¹⁰³, Montana¹⁰⁴, New York¹⁰⁵, Oklahoma¹⁰⁶, Rhode Island¹⁰⁷, and West Virginia.¹⁰⁸ For example, the Centers for Medicare and Medicaid Services has the following policy about spinal cord stimulation treatments:

...Selection of patients for implantation of spinal cord stimulators is critical to success of this therapy. SCS therapy should be considered as a late option after more conservative attempts such as medications, physical therapy, psychological therapy or other modalities have been tried...Patients must have undergone careful screening, assessment and diagnosis by a multidisciplinary team prior to implantation. Such screening must include psychological, as well as physical evaluation.⁹⁴

Test Comparisons

Q: What measures do you include in your assessment?

A: For SCS, spinal surgery and pain evaluations, over the years we have come to rely primarily on the BHI 2 and BHI 2 MIR. Actually, the reason for the name Battery for Health Improvement was our attempt to create one measure to replace the battery of tests that we used to administer for assessing pain, injury and somatization, with the hope of developing a treatment plan to help patients get better. However, sometimes we do include other assessments. If we suspect a personality disorder, and we want to know more about which type, the MCMI-IV is a good choice. If there is a forensic context and the patient is in litigation for large amounts of money, an MMPI-2RF offers excellent validity measures. If we want to know more about a patient's coping styles, we might also administer and MBMD. Lastly, if we wonder about cognitive impairment, we might do some cognitive screening or a brief assessment with a MOCA or an RBANS, respectively.

Q: If you could only use the BHI 2 or the BHI 2 MIR, which would you chose?

A: It depends on what we are trying to do. If the goal of the evaluation is to identify the risk level for a medical treatment, we would administer the BHI 2 MIR. If the goal was to develop a psychotherapeutic treatment plan, the original BHI 2 has more information about psychological constructs that would be helpful in treatment. Pearson offers a "package" price for these two reports, which makes it easy to use both.

Q: How is the BHI 2 related to the BBHI 2?

A: The BBHI 2 items are a sub-set of the BHI 2 items. While the BHI 2 has 18 scales, the BBHI 2 has six. Being shorter, the BBHI 2 takes only 9 to 10 minutes to take. In our 2009 article, we developed the original versions of the primary risk scale, and the rehabilitation risk scale. These scales were developed for both the BHI 2, and the BBHI 2. While these two scales are now included in the MIR report, they are not yet included with BBHI 2 scores. However, these scores can be hand-scored currently for the BBHI 2, using a worksheet. While hand-scoring is less convenient, and while the BBHI 2 versions of the scales are shorter and less reliable than the BHI 2 MIR versions, this BBHI 2 testing method only takes a few minutes.

Q: Will you comment on the differences between the BHI 2 and the MBMD (Millon Behavioral Medicine Diagnostic)?

A: This is a complex question. Additionally, as we are authors of the BHI 2, this biases our perception. However, in the information below, we will try to stick to objective differences between the two tests. We see them as follows:

1. First of all, a similarity between the BHI 2 and MBMD is that they are the two most prominent multidimensional health psychology inventories. They both assume that the subject being assessed is a medical patient and the intent of the assessment is to facilitate interdisciplinary treatment methods. Despite the fact that these are both health psychology inventories, they are significantly different, so much so that we do not think it would be redundant to administer both
2. The BHI 2 and MBMD were developed from different theoretical perspectives. The MBMD has as its theoretical underpinning Millon's theory of personality types, and all of his coping style scales are derived from that. Thus, the MBMD was developed in the context of trying to assess how a patient copes with chronic disease. The MBMD manual points out that all of these coping styles are thought to be non-pathological, but are a vehicle for understanding the way that different types of people cope with a serious disease. In contrast, the BHI 2 was developed on a biopsychosocial theory called "Vortex Theory." This is a theory about how multiple biological, psychological and social risk factors may combine to produce a poor outcome. The following statements are a gross oversimplification for both tests, but if we had to reduce it into a nut shell, the MBMD trends toward trying to understand how the typical person copes with the onset of disease, while the BHI 2 tries to assess the risk factors regarding why the patient may fail to respond to treatment for chronic pain, injury, or somatoform/somatic symptom disorders.
3. The MBMD manual states that when this test was constructed, 91% of the development sample of patients were diagnosed with chronic diseases classified as neurological, cancer, diabetes, cardiology and HIV, with the remaining 9% being pain patients.¹⁵² In contrast, the BHI 2 was constructed using a population that was being treated for chronic pain and/or injury.¹⁴² As the development of the BHI 2 focused on chronic pain, injury and somatic distress, the BHI 2 has many more scales and measures of pain than does the MBMD. In contrast, the MBMD contains many more scales about coping styles, as that came out of its theory.
4. The emphases of the BHI 2 and MBMD are different. In the MBMD report, there are more sentences describing the patient's strengths than in the BHI 2. In contrast, on the BHI 2, there is a greater emphasis on the assessment of patient vulnerabilities. For example, the BHI 2 is based on a considerable amount of research about patient dangerousness to self and others, addiction, adverse childhood experiences (ACE), and adult trauma, and other more serious concerns.^{76,120-122,124-126,128,129,131,136,138,153-158}
5. The MBMD and the BHI 2 differ somewhat with regard to how they assess pain patients presurgically. There are currently two major clinical methods for performing presurgical psychological evaluations. One method of assessing presurgical risk was developed by Andrew Block using the MMPI-2.¹⁵⁹ The other

method of assessing presurgical risk was the “Vortex Theory” method, using the BHI 2.^{27,76,138,140,151} The MBMD pain report utilizes predictive risk assessments that use Block’s method in one section and the Vortex method in another section. On the BHI 2 MIR, the scale that is the most similar to Block’s score is Rehabilitation Risk. During the validation of the MIR, we discovered that the BHI 2 Rehab Risk score correlated .78 with Block’s MMPI-2 based risk score. While all of these measures attempt to assess risk in these patients, each one does it somewhat differently. Note that guidelines recommend that when possible, two tests should be used for presurgical assessment, especially when the risk of adverse events is high.^{28,91}

Beyond assessing spinal surgery risk, the BHI 2 MIR differs in that it also has risk scores applicable to other clinical concerns such as response to non-spinal surgery (Rehab Risk), risk of dependence on prescription medication (Addiction History, Addiction Potential), risk of not responding to interdisciplinary care (Rehab Risk), risk of coping poorly (Catastrophizing), risk of not responding to physical therapy (Kinesiophobia, Rehab Risk), risk of dangerousness to self or others/ severe psychopathology (Primary Risk), and risk of patient litigation or retribution (contained in the MIR Primary Risk narrative). The MIR malpractice litigation algorithms were based on our research studies of predicting patients who had thoughts of filing a malpractice lawsuit. However, we also believe that this algorithm identifies patients who are at risk for filing a board complaint or trashing doctors on line. Note that the patient’s anger at physicians may or may not be justified. This is just about how the patient feels.

6. Lastly, the metrics of the BHI 2 and MBMD are different. The BHI 2 uses standardized T-scores, percentile ranks and ratings (high, very high, extremely high, etc.). In contrast, the MBMD uses “base rate scores,” which are a little more difficult to explain, but we will use a hypothetical example. Suppose 10% of the population was depressed and 5% of the population was anxious. If that was the case, then a “high” base rate score for depression should identify 10% of the population, while a “high” base rate score for anxiety should identify 5% of the population. Thus, a base rate score tells you something different than a T-score. Because of the nature of the base rate scores, however, there is no mathematical means of converting a base rate score into a percentile rank. As risk scores are generally expressed in terms of percent probability of occurrence though, the MBMD pain report lists base rate scores on one chart and percentile ranks on another. This provides two different ways (“metrics”) of determining whether a patient’s score is elevated on a particular scale. However, the challenge here is that when using two different metrics, a patient’s scale score can be high on one chart and low on the other. While there is a reason why that happens, it is more complicated to explain. Overall though, the psychometric methods used by the BHI 2 and the MBMD are quite different: Standardized T-scores on the BHI 2 versus base rate scores on the MBMD.

Risk Assessment

Q: Is this model of assessing risk for spinal cord stimulation outcome purely empirical, or is it based on a conceptual system?

A: The model is based on both empirical literature and expert consensus, which were organized together using a conceptual model that we call the vortex paradigm or vortex theory^{76,138,139}. This paradigm conceptualizes intractable medical conditions such as chronic pain as being precipitated by the cumulative effect of biological, psychological and social risk factors. The paradigm suggests falsifiable hypotheses that can be tested by multivariate methods. As noted in the webinar, just like heart disease can be predicted by an equation that includes cholesterol, age, blood pressure, diabetes, genetics etc., the vortex paradigm would predict that a response to surgery for pain can be predicted by an equation that includes depression, catastrophizing, drug abuse, personality disorder, job dissatisfaction, childhood trauma, secondary gain, etc. This is the method used during the development of the BHI 2 MIR.

Biological, psychological and social variables may all contribute to the onset of an injury or illness. Once present, a significant biological condition may have direct psychological and social consequences, and these may interact with the patient's pre-existing biological, psychological and social strengths and vulnerabilities. As the level of biopsychosocial risk factors increases, the risk of decompensation (a "downward spiral") into an intractable chronic condition increases. When the patient presents to the physician, all of these variables are present, and a treatment plan should be developed regarding how to either actively treat or manage these concerns, to prevent them from delaying recovery.

The Biopsychosocial Vortex

How intractable biopsychosocial disorders develop

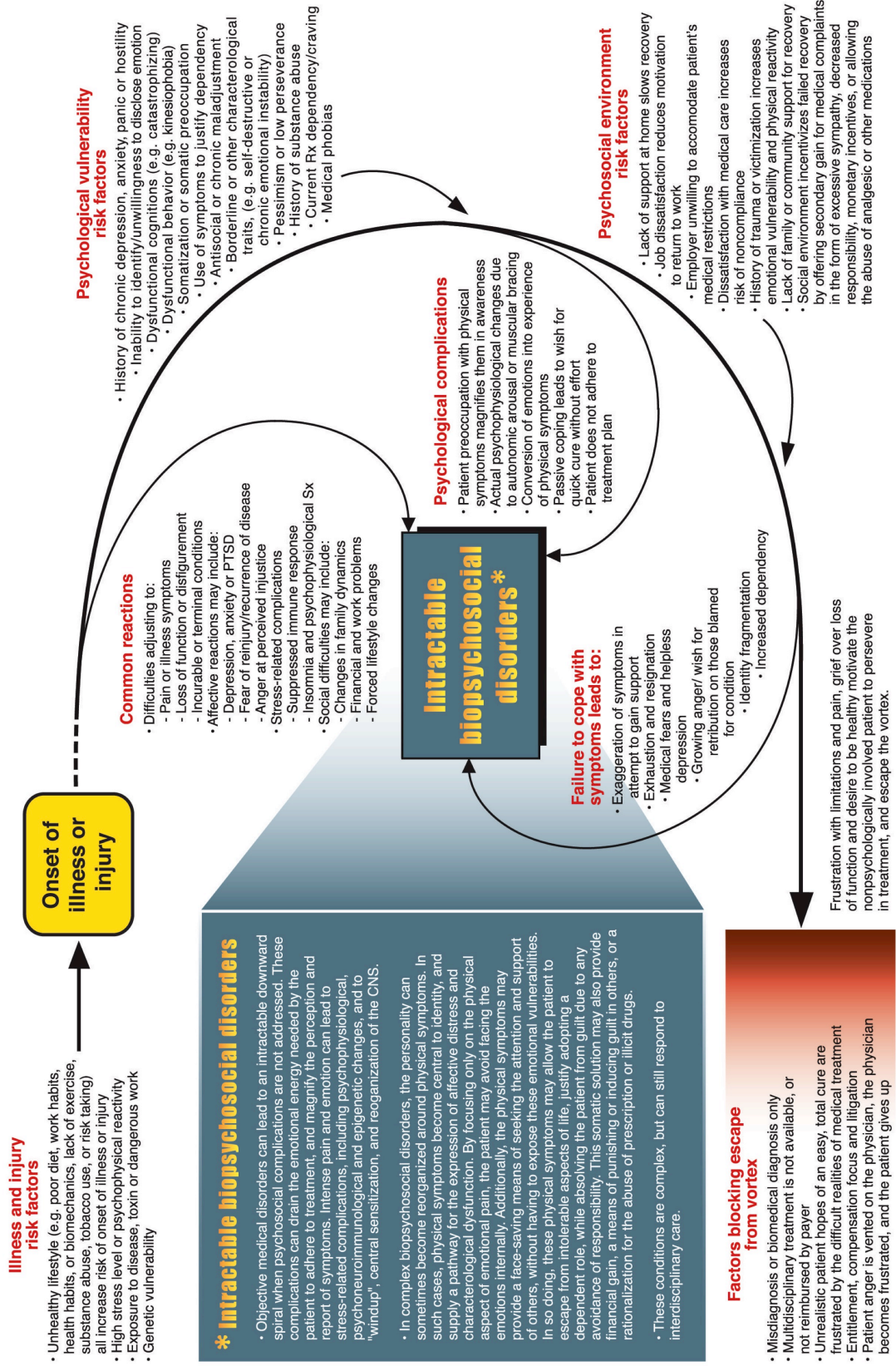

Biopsychosocial Vortex © 2016 by Daniel Bruns, PsyD and John Mark Disorbio, EdD. All Rights Reserved. Reprinted with permission.

Q: Does the BHI 2 Medical Intervention Risk (MIR) Report predict poor behavioral response to medical intervention generally? Or does it predict the outcome for specific procedures, e.g. SCS implant?

A: It can serve in both capacities. The construction of the MIR Presurgical Risk Score began by identifying risk factors shown by systematic reviews to be predictive of outcome from spinal surgery and spinal cord stimulation. The Presurgical Risk Score was then constructed using items representing these risk factors. Thus, this measure is closely associated with the SCS and spinal surgery outcome research.

In contrast, the prototype versions of two other MIR scales (Primary Risk and Rehabilitation Risk) were developed in our 2009 review paper⁷⁶. In this paper, we began by reviewing the research on psychological predictors of spinal surgery and spinal cord stimulation outcome note above. Additionally though, these measures were constructed based on the “vortex theory” of biopsychosocial outcome variables, and attempted to assess a broader set of risk for poor medical outcome from a broader set of treatments. This review generated a list of about 40 psychometric predictors, including depression, suicidality, substance abuse, personality disorder, psychosis, childhood trauma and so on. Based on that, we developed the original versions of the Primary Risk score and the Rehab Risk score. However, in this paper we then hypothesized that the risk factors we identified would likely interfere with most all forms of medical treatment, and tested this on 1254 patients. If you think about it, if the patient is severely depressed, is dependent on opioids, suffers from a personality disorder, hates physicians and hallucinates, what medical treatment would the patient likely do well at? Consequently, we then tested these risk scales on multiple patient groups. This included patients who were, a) undergoing spinal surgeries, b) undergoing arm or leg surgeries, c) in treatment for chronic pain, d) in acute physical therapy, e) worker compensation patients, f) medical litigation claimants, and g) patients undergoing treatment for brain injury. In almost all cases, these two scales were consistently significantly associated with both subjective and objective outcomes across all of these various groups. Thus, this supports the hypothesis that these scales are broadly applicable across medical diagnoses and treatments.

Q: Some of the pain clinics are now asking for an assessment for candidacy for successful opioid treatment. Can this be used for that too?

A: Yes. Although the original BHI has a Substance Abuse scale, the best BHI 2 measures for the purpose you mentioned would be the Addiction History and Addiction Potential scales on the MIR. As discussed in the webinar, the Addiction History scale identifies patients with a history of substance abuse, associated with anti-social behavior, incarceration, driving while intoxicated, failed substance use treatment, polysubstance abuse, etc. For patients high on this scale, opioids could become their next drug of choice. Note, however, that the Addiction History scale contains a lot of information that is socially undesirable. If a patient is low on the Self-Disclosure validity scale on the

BHI 2, then they might be concealing important information here. Thus, if a patient is very low or extremely low on Self-Disclosure, it would be good to review medical records or ask the patient's family about addictive history to verify this.

On the other hand, a high Addiction Potential score identifies patients with extreme pain, poor coping, unreasonable expectations, high distress and medication craving. Elevations on either of these two measures indicate concerns. Elevation on both is more concerning.

Q: How significant of a factor is involvement in the workers' compensation claim? Some studies have been very negative about his contextual factor.

A: Workers' compensation is a unique payer system, where secondary gain is present. Patients who are symptomatic are often provided with disability pay without having to go to work. Additionally, if they do badly in treatment, they may get a larger settlement at the end as a reward. This can reduce motivation in treatment and incentivize patients to report more symptoms.

That being said, in our opinion some articles overly vilify workers' compensation patients. If you fall off a roof and shatter your leg, you should get the same medical treatment, regardless of whether or not you were at work when the accident happened. We conducted a very large study of workers' compensation patients. This was a study of 29 million injured workers, over a period of 15 years. In this study, we tested the effect of using a biopsychosocial model like the one we discussed in this webinar. This study compared workers compensation patients who received aggressive biopsychosocial care, versus those worker compensation patients that received more traditional biomedical care. This study found that in one year, the use of a biopsychosocial approach with workers' compensation patients in one state saved that state almost a billion dollars, while reducing disability.¹¹⁸

If you are using the BHI 2 MIR, and you are assessing a workers' compensation patient, make sure to list in the demographics that it is a workers' compensation patient, the date of injury, tobacco use and whether or not the patient has an attorney. If you do, those facts will be included in the MIRs risk algorithm calculations. Additionally, note that the BHI 2 "Biopsychosocial Vortex" theory¹³⁹ was adopted as the theoretical paradigm for the ACOEM Pain Treatment Guidelines, which is the national worker compensation pain treatment guidelines.²⁷

Q: What would a "good" workers' compensation patient look like if being considered for an SCS? What is a deal breaker?

A: Research on medical treatment outcomes shows that workers' compensation status is a "yellow flag" risk factor for SCS and other medical treatment outcomes. On the MIR report, if you select workers' compensation as the payer, it calculates in workers' compensation as a risk factor with all of the other risk factors, when calculating the

overall recommendation. Thus, workers' compensation is "baked in" to the MIRs algorithms. Additional related risk factors are also calculated in, including the presence of litigation, cognitive compensation focus, medical entitlement, depression, widespread pain, perception of disability, relationship with physicians and so on. All of these risk factors are "yellow flags," and as more are present the risk of poor outcome increases. The "deal breaker" is not the presence of any single risk factor. The "deal breaker" has to do with the number of yellow flag risk factors being present.

Q: With what other clinical populations can this instrument be used?

A: The BHI 2 and BHI 2 MIR were designed for use with the following populations.

1. Half of the BHI 2 patient normative sample reported chronic and half acute conditions. The majority of these patients had pain/injury, but some did not. Any patient where pain is a problem is appropriate for assessment.
2. The patients in the BHI 2 norm group were further stratified into those with acute pain, chronic pain, headache pain, neck pain, arm pain, back pain, and leg pain groups. The BHI 2 headache pain group was comprised of about half TBI headache pain and half non-TBI headache pain.
3. Because of the Job Dissatisfaction scale, the BHI 2 norm group had an upper age range at age 65. Clinically, we have found that the BHI 2 patient norms are useful for patients older than that, although we are more cautious with those interpretations. An important consideration here is if the test subject is a frail elderly patients who has deteriorating health. In the later stages of life, patients may develop multiple serious medical conditions that tend to elevate their responses to health psych inventories generally. All health psychology tests need to be interpreted with this in mind.
4. While the BHI 2 development was more closely associated with pain associated with injury, some of the scales and measures were specifically designed for illness-related pain. For example, the death fears scale was designed to assess patients with conditions such as cancer-related pain. However, if a patient with an ankle sprain is afraid of dying from that, it is a phobia!
5. The BHI 2 also provides extensive assessment for somatic symptom/somatoform-type disorders, such as somatization, conversion disorders, somatic symptom disorders, etc. In this webinar, the slides associated with "the psychological fallacy" very briefly addressed a few of the features associated with the BHI 2 assessment of somatic symptoms other than pain.
6. The BHI 2 also assesses pain associated with physical or psychological trauma (Survivor of Violence assesses adverse child and adult experiences).

7. The BHI 2 also has a community sample and using that sample can also assess health risk factors in patients who did not have a medical condition. Although the BHI 2 is used less often for this, this is also a potential use.

Validity Assessment and Decisions

Q: Does the BHI 2 have a validity scale?

A: The BHI 2 has multiple validity measures.

1. First of all, the BHI 2 contains four very bizarre items. Almost 99% of those taking the test will respond in a certain way to them. Patients who endorse two or more of these items may be responding randomly, have literacy problems or have very bizarre ideation.
2. Secondly, the BHI 2 has a scale called Defensiveness. This scale was developed by recruiting 100 pain patients, and paying them to subtly fake good and subtly fake bad (e.g. subjects were told that if they faked in an extreme way they would get caught, so they should be subtle about it). All of these patients were then administered 600 questions, and the ones they answered differently from non-faking patients were used to develop the Defensiveness scale.¹⁴² It was later cross validated by repeating this process with second group of 100 pain patients.
3. Third, the BHI 2 also has a scale called Self-Disclosure. This is composed of items having to do with personal information about dysfunctional thoughts, feelings and behavior. This measure estimates the degree to which a patient is willing to disclose personal information about his/herself. Both the Defensiveness scale and the Self-Disclosure scale are bi-directional, meaning that they can both be unusually high, or unusually low.
4. While the above are the three main validity scales, the BHI 2 also examines more specific ways that patients may bias information. For example, with only a couple of exceptions, all of the BHI 2 scales are bi-directional, and in some cases this is particularly significant. If a patient has an extremely low Hostility score, it may be that s/he has difficulty recognizing or expressing angry feelings. This is important as somatizers, by definition, under report their emotions, and over report physical symptoms.
5. Lastly, while some tests are invalidated if more than x number of items are left blank, on the BHI 2, blank responses invalidate one scale at a time if $\geq 25\%$ of items on that scale are left blank. For example, if a patient refuses to answer most questions about his or her family, and leaves 60% of the items on Family Dysfunction

scale blank, this will invalidate the Family Dysfunction scale. However, all of the other scales on the BHI 2 will be interpreted, as they were not affected by this pattern of blank responses.

Thus, on the BHI 2, all of these methods can be used to understand how a patient presents him/herself.

BHI 2 Validity Scale Profiles			
		Defensiveness Biased reports regarding life and circumstances	
		Defensiveness Low	Defensiveness High
Self Disclosure Biased reports regarding self	Self Disclosure Low	Life is terrible I have no psych problems Super stoic	Life is great I have no psych problems Consistent positive bias
	Self Disclosure High	Life is terrible I am dysfunctional Consistent negative bias	Life is great I am dysfunctional Fragile person

Q: What do you do with an invalid BHI 2 (MIR) result due to faking good/bad?

A: This is an excellent question, although a complex one. As above, there are different types of invalidity conditions, many circumstances in which they can occur, and differing implications. Here are a few thoughts:

1. As noted above, BHI 2 scales are invalidated by blank responses one scale at a time. Sometimes scales are invalidated because the patient has privacy issues, and does not want to disclose anything about the family, past trauma, feelings about the employer, etc. In some cases, the patient's rationale for this is understandable.

2. Sometimes patients achieve an invalid BHI 2 profile due to responses to the extreme validity items. In this case, the patient is either illiterate, is having a visual-motor problem (e.g. forgot their glasses, marks dot on wrong line), responding randomly, or has very bizarre ideation. While patients with paranoid psychosis sometimes score high on these extreme items and their responses are meaningful, generally endorsement of two or more validity items means that the patient's responses to the entire test are not valid.

3. A third type of validity question arises when there is an extreme bias detected by the Defensiveness or Self-Disclosure scales. Note that both Defensiveness and Self-Disclosure can range from extremely high to extremely low scores. However, extreme scores on these two scales do not invalidate the BHI 2. Rather, they only tell you that the patient may have presented in one extreme way or the other, and they may do that for different reasons. These profiles are interpreted.
 - a. The Defensiveness scale assesses the tendency to distort the portrayal of one's life and circumstances. Highly defensive patients will describe their life as "great." In contrast, patients who "drop their defenses" will get a low Defensiveness score, suggesting that they are describing their lives in highly negative terms.

 - b. The Self Disclosure scale assesses the degree to which a patient will reveal information about any personal dysfunctional tendencies. A low score suggests the patient is being very private and does wish to share his/her thoughts and feelings with you. In contrast, patients with a high score may be either accurately describing a high level of psychological dysfunction, or describing themselves in an overly negative fashion.

 - c. Sometimes patients who appear to be "faking bad" may be trying to exaggerate their complaints in order to get what they want. Thus, a patient may exaggerate their distress saying, "My pain is so bad that I can never do any kind of work again." Alternately, if the reason for the referral is that the patient is suing for a million dollars for pain and suffering, a biased type of profile might be the report of extreme physical symptoms while claiming to be extraordinarily virtuous. So, the context can change how the test results are interpreted. If Self Disclosure is extremely high, the patient may be motivated to exaggerate psychological distress, either for compensation or as a "cry for help". Related to this, patients with extremely low Defensiveness scores are "lowering their defenses" so as to report more negative information about life and circumstances. As the scores move further from the mean, there is increased risk that the patient is using the extreme reports to create a certain impression. Whenever scores are extreme, it is good to ask "Is this patient biasing the responses to get

something or avoid something?” That something could be a stimulator, opioids, disability pay, or light duty at work, and the interview helps you to understand the context.

- d. On other occasions, sometimes patients present as extremely psychologically healthy (extremely low on Self Disclosure), feeling that if they reveal any psychological weaknesses, their medical symptoms will be taken less seriously. This is more likely to occur in an SCS evaluation if the referring physician sets them up to believe this. Some physicians will refer a patient by saying, “You are an excellent candidate for surgery X. Unfortunately, the evil insurance company will make you jump through this hoop of going through a psychological evaluation. You have to show that you are not crazy, and that the pain is not in your head.” (Some physicians actually say things like this). Thus, if patients comes into the evaluation expecting some kind of psychological inquisition to invalidate their claim, it sets them up to appear highly defensive, and to distort their portrayal of their life in a highly positive manner. Unfortunately, low and very low Self Disclosure scores will create “yellow flags” on the MIR, and extremely low Self Disclosure scores (below the first percentile) will create a “red flag” on the MIR.
- e. If you think that the physician is preparing the patient for the psych eval in a problematic way, you may wish to offer the MD some instruction. For example, you could say to the physician something like this:

If you were referring the patient for an MRI, you wouldn't tell the patient “While you're in the MRI tube, try to move around as much as possible.” Obviously, that would create MRI results that are unusable. Similarly, it is possible to give instructions for a psych eval referral that renders the psych testing unusable as well. If you tell a patient that “The insurance company wants to prove you are crazy so they can deny coverage for the spinal cord stimulation.” If you do that, on psychological testing the patient will tend to describe themselves as psychologically perfect. Patients who are clearly biasing their report will appear to be untruthful on psychometric measures of validity, and this tends to make the patient look bad, as if they are faking. Additionally, if the patient portrays him or herself as happier than 99% of the healthy population, and as having no risk factors whatsoever, why would you ever do surgery if the patient was that extraordinarily happy with things the way they are? So, those instructions are problematic, and increase the risk that the patient will fail the assessment. A better way to refer the patient for the psychological evaluation is as follows: “As your physician, I'm concerned about your pain, and I'm concerned about your stress and emotional welfare as well. In order to understand what treatments might be best for you, I'd like you to undergo this behavioral evaluation. I fully expect that you have some stress in your life, anybody with chronic pain has stress. This

psychological evaluation will help me to better understand your better, and help me select the best treatments for you.” The patient who is told something like that is more likely to cooperate with the psych eval, and less likely to exhibit a “fake good” profile.

4. One of the ways we try to prevent biased responding is when we prepare the patient for psychological assessment. We explain to the patient our commitment to the “best practice model,” which is that our goal is to find the best treatment for that particular patient. Sometimes patients are looking for a magical solution, such as a surgery that will “cut the pain out of me,” a treatment that will not require any effort or change on their part. We try to explain to patients that in order for us to provide them the best treatment, we need for them to do their most accurate job of describing their symptoms. Based on that report of symptoms, we will try to identify the best treatments for them. For patients who present themselves in extreme ways, we process that with them afterward if they are treating with us. If they presented in an extremely defensive/positive way, we explore any privacy concerns they may have, and state that it would help us help them better if we understood them better. If patients present in an extremely negative way, we explain to them the nature of catastrophizing. If everything in their life seems absolutely horrible now, they are more likely to focus on the negative aspects of their surgical outcome later on.
5. For patients who have a red flag due to extremely low Self Disclosure, it indicates that the patient is going to extreme lengths to reveal nothing. This creates a primary risk factor, as you don’t know what the patient is concealing. This pattern can be seen in patients with severe somatic symptoms/somatoform disorders who are characterologically prone to over-reporting physical symptoms, and under-reporting psychological symptoms. These patients tend to be alexithymic, and have a reduced level of emotional awareness. On the other hand, in some cases this extremely low Self Disclosure score can be observed if either the referring physician, SCS manufacturer rep or someone else conveys to the patient that this psych eval is very adversarial, is intended to prove that the patient is crazy and that the symptoms are “all in your head,” and that any psychological weaknesses that the patient admits to will be used to deny treatment. If we believe the second scenario is the case, we offer the to give the patient a “mulligan” and allow them to retake the test. We may say something like this to the patient:

“It looks like you were concerned about disclosing much information on the questionnaire. Maybe you were concerned about privacy, or that anything you said would be used against you. Unfortunately, this makes you look impossibly happy, and like your life is perfect despite your pain, even more way more happy than healthy people. If you are really that happy, why would we put you through a stressful surgery? But I am guessing that this was probably about you being concerned about disclosing information. Our job is to help you, and in order to give

- you the best treatment, we need to understand how you are doing, and know about your pain, symptoms, emotional stress and frustrations. Do you want me to turn in the report as is, or do you want to give it another try?" Note that we would never do this in a forensic evaluation, but might in a treatment evaluation.
6. Occasionally, extreme scores are seen when the patient is refusing to cooperate with the evaluation. This scenario has been relatively rare for us, but occurs sometimes when the evaluation is perceived in highly adversarial terms by the patient.

Billing and Coding

Q: Do you bill more than 90791 (and seek additional authorization for testing)?

A: First of all note that this is time sensitive information, and that billing and coding policies change over time. Secondly, note that billing and coding policies vary across payers. While we hope that the information here is helpful, we would strongly encourage you to consult a billing a coding expert who is familiar with your payers, and to always follow the rules. That being said, we currently bill for 96101 whenever we administer standardized tests, which are recommended or required by many guidelines. The exception is that when you bill for a psychological testing like 96101, this code should not be used for billing for screening measures, such as a PHQ9. However, all the other tests mentioned above, BHI 2, MBMD, MCMI IV or MMPI 2 are all standardized tests for which 96101 is appropriate for billing. Note that billing 96101 allows you to bill for non-face-to-face time, such as that in chart review or report preparation, and you can bill for more than one unit (1 unit = 1 hour) of this based on the time you spend. Also note that as you can use more than one unit of 96101, it uses a "rounding rule." At 31 minutes of time you can bill one unit of 96101. At 91 minutes of time, you can bill for 2 units. Note that you get reimbursed the same amount for any session length from 31 to 90 minutes, so at 31 minutes you are making 3X more dollars per hour, etc.

The CPT code 90791 refers to a "psychiatric diagnostic evaluation." This code is task-based not time based, as unlike psychotherapy codes no time frame is specified. How fast can you get it done? There are different ways that 90791 and 96101 codes can be used together. Presurgical psychological assessments can be longer or shorter in length depending on a variety of factors including the complexity of the case, the risk of adverse events due to the surgery, and guideline recommendations. Note that some guidelines suggest that presurgical psychological evaluations should include both a health psychology test and a psychiatric test.^{28,91} In some practice settings though, psychologists may be under considerable pressure to perform these evaluations more quickly, there may be limitations in payer reimbursement, etc. In those cases, the psychologist will need to make decisions about how to best address the referral

questions in the time available. Note that we have published book chapters on billing and coding^{160,161}, and on how to conduct psych evals for medical patients.^{77,78,112,139,143}

Q: In submitting claims to third party payers, what diagnoses do payers accept for patients without a psychological diagnosis?

A: Payers have all different policies about what they cover, but we can make some general statements for consideration.

1. We often use the code F45.42—Pain Disorder. While this is a code that was in DSM IV, it is not in DSM 5. However, this code remains in ICD 10 and is still a valid code, and is commonly used for patients with chronic pain. This code may be paid by mental health payers, as it is still classified as a behavioral disorder.
2. In contrast, there is a code G89.4—Chronic Pain Syndrome. The descriptor of that condition is very similar to that of F45.42—Pain Disorder. However, G89.4 is classified under Neurology and thus is typically reimbursed by medical payers.
3. If you are using the health and behavior CPT codes to bill (96150: one or more 15 minute units), you can bill for treating any medical diagnosis ranging from herniated lumbar disc, to diabetic peripheral neuropathy. Often, there is no single “right” way to bill and code these services, and sometimes different payers, such as Medicare, Medicaid and private payers have different rules. It will be important to consult a billing and coding expert in your region and to always follow the applicable rules.

Case Vignette

Q: How do you approach feedback with a patient who is very focused on pain reduction and is not happy with the suggestion to focus on the “yellow flags” first? (i.e., “If my pain was lower, I’d be less anxious/depressed, angry/etc.).

A: We are going to estimate that half or more of our patients arrive for our first session saying something like, “I don’t need to be here. I am not crazy; this is not in my head. If my pain was lower, I would not be so frustrated.” We then allow the patients to start talking about their frustrations and often when they start talking about how frustrated they are, they don’t want to stop. So the key is to find ways to engage these patients. Somatizers, by definition, under report their psychological symptoms. Unconsciously, they may be trying to find a surgery that will cut out their unhappiness.

We think it is extremely important to frame psychological services to patients in a helpful way, as a referral to a psychologist can be threatening. The psychological referral can become framed as a moral judgment. That is, the patient may fear that what the psychologist is thinking is, “I am going to psychologically evaluate you, to see if you are psychologically worthy of us doing surgery on you, or if you are so psychologically screwed up that you don’t deserve these treatments.” Even though this is not the way these treatments were intended, sometimes patients misperceive it this way. We think it is important to frame these presurgical evaluations in a more positive way, in that we are trying to recommend treatments that the patient is most likely to be satisfied with. We tell patients that we are committed to giving them the best care, and then try to explain what that care is based on science.

Another matter to consider is that the “psychological clearance model” of SCS referrals¹⁵¹ is often frustrating for patients. In this model, patients are simply “cleared” to proceed with surgery or not. For those patients who are not cleared, it can be extremely disheartening if nothing else is offered. In contrast, in the “best practice model” the purpose of the SCS psych eval is to seek the best treatment for the patient. If the patient is at high risk to be disappointed with or fail to benefit from SCS, what would you suggest? For patients who “can’t take the pain one more minute” Dialectical Behavior Therapy has helpful methods of improving frustration tolerance.¹⁶²

Links

Watch the webinar/view the slides

http://bit.ly/SCS_psych_evals

http://bit.ly/scs_webinar_slides

Related webinars

http://bit.ly/presurgical_psych_assessment

http://bit.ly/pain_explained

http://bit.ly/MIR_Explained

healthpsych.com spinal cord stimulation page and related links

<http://www.healthpsych.com/scs.html>

http://bit.ly/scs_glossary

http://bit.ly/SCS_QandA

[\(more Q&A about SCS\)](#)

Getting on insurance panels

http://bit.ly/getting_on_panels

Coding diagnoses for pain

http://bit.ly/icd10_dsm5

Billing and coding

http://bit.ly/psych_billing

(best strategies for reimbursement, potential for trainee reimbursement)

healthpsych.com YouTube channel

http://bit.ly/psych_webinars

(videos for pain assessment)

* * *

For additional information, including webinars and a pictorial glossary of SCS-related terms, go to www.healthpsych.com/scs.html

References

1. International Neuromodulation Society. Neuromodulation, or Neuromodulatory Effect. 2013; <http://www.neuromodulation.com/neuromodulation-defined>. Accessed July 8, 2017.
2. Chakravarthy K, Nava A, Christo PJ, Williams K. Review of Recent Advances in Peripheral Nerve Stimulation (PNS). *Curr Pain Headache Rep*. 2016;20(11):60.
3. Morch CD, Nguyen GP, Wacnik PW, Andersen OK. Mathematical model of nerve fiber activation during low back peripheral nerve field stimulation: analysis of electrode implant depth. *Neuromodulation*. 2014;17(3):218-225; discussion 225.
4. Schu S, Gulve A, ElDabe S, et al. Spinal cord stimulation of the dorsal root ganglion for groin pain-a retrospective review. *Pain Pract*. 2015;15(4):293-299.
5. Forget P, Boyer T, Steyaert A, Masquelier E, Deumens R, Le Polain de Waroux B. Clinical evidence for dorsal root ganglion stimulation in the treatment of chronic neuropathic pain. A review. *Acta Anaesthesiol Belg*. 2015;66(2):37-41.
6. Yang Y, Song M, Fan Y, Ma K. Occipital Nerve Stimulation for Migraine: A Systematic Review. *Pain Pract*. 2016;16(4):509-517.
7. Sweet JA, Mitchell LS, Narouze S, et al. Occipital Nerve Stimulation for the Treatment of Patients With Medically Refractory Occipital Neuralgia: Congress of Neurological Surgeons Systematic Review and Evidence-Based Guideline. *Neurosurgery*. 2015;77(3):332-341.
8. Ghoname EA, Craig WF, White PF, et al. Percutaneous electrical nerve stimulation for low back pain: a randomized crossover study. *Jama*. 1999;281(9):818-823.
9. Hamza MA, White PF, Craig WF, et al. Percutaneous electrical nerve stimulation: a novel analgesic therapy for diabetic neuropathic pain. *Diabetes Care*. 2000;23(3):365-370.
10. Gaziev G, Topazio L, Iacovelli V, et al. Percutaneous Tibial Nerve Stimulation (PTNS) efficacy in the treatment of lower urinary tract dysfunctions: a systematic review. *BMC Urol*. 2013;13:61.
11. Cummings M. Percutaneous electrical nerve stimulation--electroacupuncture by another name? A comparative review. *Acupunct Med*. 2001;19(1):32-35.
12. Biemans JM, van Balken MR. Efficacy and effectiveness of percutaneous tibial nerve stimulation in the treatment of pelvic organ disorders: a systematic review. *Neuromodulation*. 2013;16(1):25-33; discussion 33.
13. Ramage L, Qiu S, Kontovounisios C, Tekkis P, Rasheed S, Tan E. A systematic review of sacral nerve stimulation for low anterior resection syndrome. *Colorectal Dis*. 2015;17(9):762-771.
14. Carrington EV, Evers J, Grossi U, et al. A systematic review of sacral nerve stimulation mechanisms in the treatment of fecal incontinence and constipation. *Neurogastroenterol Motil*. 2014;26(9):1222-1237.

15. Connor DE, Jr., Nixon M, Nanda A, Guthikonda B. Vagal nerve stimulation for the treatment of medically refractory epilepsy: a review of the current literature. *Neurosurg Focus*. 2012;32(3):E12.
16. Chakravarthy K, Chaudhry H, Williams K, Christo PJ. Review of the Uses of Vagal Nerve Stimulation in Chronic Pain Management. *Curr Pain Headache Rep*. 2015;19(12):54.
17. Krahl SE. Vagus nerve stimulation for epilepsy: A review of the peripheral mechanisms. *Surg Neurol Int*. 2012;3(Suppl 1):S47-52.
18. Berry SM, Broglio K, Bunker M, Jayewardene A, Olin B, Rush AJ. A patient-level meta-analysis of studies evaluating vagus nerve stimulation therapy for treatment-resistant depression. *Med Devices (Auckl)*. 2013;6:17-35.
19. Martinez-Martinez AM, Aguilar OM, Acevedo-Triana CA. Meta-Analysis of the Relationship between Deep Brain Stimulation in Patients with Parkinson's Disease and Performance in Evaluation Tests for Executive Brain Functions. *Parkinsons Dis*. 2017;2017:9641392.
20. Papageorgiou PN, Deschner J, Papageorgiou SN. Effectiveness and Adverse Effects of Deep Brain Stimulation: Umbrella Review of Meta-Analyses. *J Neurol Surg A Cent Eur Neurosurg*. 2017;78(2):180-190.
21. Naesstrom M, Blomstedt P, Bodlund O. A systematic review of psychiatric indications for deep brain stimulation, with focus on major depressive and obsessive-compulsive disorder. *Nord J Psychiatry*. 2016;70(7):483-491.
22. Previnaire JG, Nguyen JP, Perrouin-Verbe B, Fattal C. Chronic neuropathic pain in spinal cord injury: efficiency of deep brain and motor cortex stimulation therapies for neuropathic pain in spinal cord injury patients. *Ann Phys Rehabil Med*. 2009;52(2):188-193.
23. Babu R, Hazzard MA, Huang KT, et al. Outcomes of percutaneous and paddle lead implantation for spinal cord stimulation: a comparative analysis of complications, reoperation rates, and health-care costs. *Neuromodulation*. 2013;16(5):418-426; discussion 426-417.
24. Kemler MA, Barendse GA, van Kleef M, et al. Spinal cord stimulation in patients with chronic reflex sympathetic dystrophy. *N Engl J Med*. 2000;343(9):618-624.
25. Kapural L, Yu C, Doust MW, et al. Comparison of 10-kHz High-Frequency and Traditional Low-Frequency Spinal Cord Stimulation for the Treatment of Chronic Back and Leg Pain: 24-Month Results From a Multicenter, Randomized, Controlled Pivotal Trial. *Neurosurgery*. 2016;79(5):667-677.
26. Kapural L, Yu C, Doust MW, et al. Novel 10-kHz High-frequency Therapy (HF10 Therapy) Is Superior to Traditional Low-frequency Spinal Cord Stimulation for the Treatment of Chronic Back and Leg Pain: The SENZA-RCT Randomized Controlled Trial. *Anesthesiology*. 2015;123(4):851-860.
27. Hegmann K. Chronic pain guidelines. *MDGuidelines®. Occupational medicine practice guidelines: Evaluation and Management of Common Health Problems and Functional Recovery in Workers* 2017; 3rd:www.mdguidelines.com. Accessed July 1, 2017.
28. Colorado Division of Workers' Compensation. Rule 17, Exhibit 9: Chronic Pain Disorder Medical Treatment Guidelines. *Colorado Medical Treatment Guidelines* 2017; 2017:<http://www.healthpsych.com/tools/chronicpain.pdf>. Accessed July 4, 2017.

29. Buvanendran A, Lubenow TJ. Efficacy of transverse tripolar spinal cord stimulator for the relief of chronic low back pain from failed back surgery. *Pain Physician*. 2008;11(3):333-338.
30. North RB, Kidd DH, Farrokhi F, Piantadosi SA. Spinal Cord Stimulation versus Repeated Lumbosacral Spine Surgery for Chronic Pain: A Randomized, Controlled Trial. *Neurosurgery*. 2005;56(1):98-107.
31. Kumar K, Taylor RS, Jacques L, et al. The effects of spinal cord stimulation in neuropathic pain are sustained: a 24-month follow-up of the prospective randomized controlled multicenter trial of the effectiveness of spinal cord stimulation. *Neurosurgery*. 2008;63(4):762-770; discussion 770.
32. Kemler MA, De Vet HC, Barendse GA, Van Den Wildenberg FA, Van Kleef M. The effect of spinal cord stimulation in patients with chronic reflex sympathetic dystrophy: two years' follow-up of the randomized controlled trial. *Ann Neurol*. 2004;55(1):13-18.
33. Kemler MA, de Vet HC, Barendse GA, van den Wildenberg FA, van Kleef M. Effect of spinal cord stimulation for chronic complex regional pain syndrome Type I: five-year final follow-up of patients in a randomized controlled trial. *J Neurosurg*. 2008;108(2):292-298.
34. Carragee EJ, Cheng I. Minimum acceptable outcomes after lumbar spinal fusion. *Spine J*. 2010;10(4):313-320.
35. Farrar JT, Berlin JA, Strom BL. Clinically important changes in acute pain outcome measures: a validation study. *J Pain Symptom Manage*. 2003;25(5):406-411.
36. American College of Occupational and Environmental Medicine. Chronic pain guidelines. *MDGuidelines®. Occupational medicine practice guidelines: Evaluation and Management of Common Health Problems and Functional Recovery in Workers 2017*; 3rd:www.mdguidelines.com. Accessed July 1, 2017.
37. Jain N, Phillips FM, Weaver T, Khan SN. Pre-operative Chronic Opioid Therapy: A Risk Factor for Complications, Readmission, Continued Opioid Use and Increased Costs After One- and Two-Level Posterior Lumbar Fusion. *Spine (Phila Pa 1976)*. 2018.
38. Sharma M, Ugiliweneza B, Sirdeshpande P, Wang D, Boakye M. Opioid Dependence and Health Care Utilization Following Decompression and Fusion in Patients with Adult Degenerative Scoliosis. *Spine (Phila Pa 1976)*. 2018.
39. Bruns D, Disorbio JM. *BHI 2 Medical Intervention Risk (MIR) Report Manual*. Minneapolis: Pearson; 2016.
40. Hayek SM, Veizi E, Hanes M. Treatment-Limiting Complications of Percutaneous Spinal Cord Stimulator Implants: A Review of Eight Years of Experience From an Academic Center Database. *Neuromodulation*. 2015;18(7):603-608; discussion 608-609.
41. Forouzanfar T, Kemler MA, Weber WE, Kessels AG, van Kleef M. Spinal cord stimulation in complex regional pain syndrome: cervical and lumbar devices are comparably effective. *Br J Anaesth*. 2004;92(3):348-353.
42. Perruchoud C, Eldabe S, Batterham AM, et al. Analgesic efficacy of high-frequency spinal cord stimulation: a randomized double-blind placebo-controlled study. *Neuromodulation*. 2013;16(4):363-369; discussion 369.
43. Kohl A, Rief W, Glombiewski JA. Acceptance, cognitive restructuring, and distraction as coping strategies for acute pain. *J Pain*. 2013;14(3):305-315.

44. Bruns D, Disorbio JM. Q&A: Biopsychosocial Risk Factors for Spinal Cord Stimulation. *Pain Practitioner*. 2017;27(3):19-22.
45. Guan Y. Spinal cord stimulation: neurophysiological and neurochemical mechanisms of action. *Curr Pain Headache Rep*. 2012;16(3):217-225.
46. Meyerson BA, Linderoth B. Mode of action of spinal cord stimulation in neuropathic pain. *J Pain Symptom Manage*. 2006;31(4 Suppl):S6-12.
47. Buonocore M. Neurophysiological Responses for Better Understanding the Antalgic Mechanisms of Spinal Cord Stimulation. *Journal of Pain & Relief*. 2013;2(2):1-4.
48. Holsheimer J, Buitenweg JR. Review: Bioelectrical mechanisms in spinal cord stimulation. *Neuromodulation*. 2015;18(3):161-170; discussion 170.
49. Bentley LD, Duarte RV, Furlong PL, Ashford RL, Raphael JH. Brain activity modifications following spinal cord stimulation for chronic neuropathic pain: A systematic review. *Eur J Pain*. 2016;20(4):499-511.
50. Vallejo R, Bradley K, Kapural L. Spinal Cord Stimulation in Chronic Pain: Mode of Action. *Spine (Phila Pa 1976)*. 2017.
51. Dilley A, Richards N, Pulman KG, Bove GM. Disruption of fast axonal transport in the rat induces behavioral changes consistent with neuropathic pain. *J Pain*. 2013;14(11):1437-1449.
52. Torgerson NA, Bright KL, Buse ND. Electrical stimulation therapy for inducing patient sensations. In: Google Patents; 2017.
53. Kriek N, Groeneweg JG, Stronks DL, de Ridder D, Huygen FJ. Preferred frequencies and waveforms for spinal cord stimulation in patients with complex regional pain syndrome: A multicentre, double-blind, randomized and placebo-controlled crossover trial. *Eur J Pain*. 2017;21(3):507-519.
54. De Ridder D, Vanneste S, Plazier M, Vancamp T. Mimicking the brain: evaluation of St Jude Medical's Prodigy Chronic Pain System with Burst Technology. *Expert Rev Med Devices*. 2015;12(2):143-150.
55. Kandel ER, Schwartz JH, Jessell TM. *Principles of neural science*. 4th ed. New York: McGraw-Hill, Health Professions Division; 2000.
56. Kocyigit F, Akalin E, Gezer NS, Orbay O, Kocyigit A, Ada E. Functional magnetic resonance imaging of the effects of low-frequency transcutaneous electrical nerve stimulation on central pain modulation: a double-blind, placebo-controlled trial. *The Clinical journal of pain*. 2012;28(7):581-588.
57. Borckardt JJ, Reeves ST, Beam W, et al. A randomized, controlled investigation of motor cortex transcranial magnetic stimulation (TMS) effects on quantitative sensory measures in healthy adults: evaluation of TMS device parameters. *The Clinical journal of pain*. 2011;27(6):486-494.
58. Ahmed MA, Mohamed SA, Sayed D. Long-term antalgic effects of repetitive transcranial magnetic stimulation of motor cortex and serum beta-endorphin in patients with phantom pain. *Neurological research*. 2011;33(9):953-958.
59. Avery DH, Zarkowski P, Krashin D, et al. Transcranial magnetic stimulation in the treatment of chronic widespread pain: a randomized controlled study. *The journal of ECT*. 2015;31(1):57-66.

60. Yilmaz B, Kesikburun S, Yasar E, Tan AK. The effect of repetitive transcranial magnetic stimulation on refractory neuropathic pain in spinal cord injury. *The journal of spinal cord medicine*. 2014;37(4):397-400.
61. Jin Y, Xing G, Li G, et al. High Frequency Repetitive Transcranial Magnetic Stimulation Therapy For Chronic Neuropathic Pain: A Meta-analysis. *Pain Physician*. 2015;18(6):E1029-1046.
62. O'Connell NE, Cossar J, Marston L, et al. Transcranial direct current stimulation of the motor cortex in the treatment of chronic nonspecific low back pain: a randomized, double-blind exploratory study. *The Clinical journal of pain*. 2013;29(1):26-34.
63. Galhardoni R, Correia GS, Araujo H, et al. Repetitive transcranial magnetic stimulation in chronic pain: a review of the literature. *Archives of physical medicine and rehabilitation*. 2015;96(4 Suppl):S156-172.
64. Lefaucheur JP, Andre-Obadia N, Antal A, et al. Evidence-based guidelines on the therapeutic use of repetitive transcranial magnetic stimulation (rTMS). *Clinical neurophysiology : official journal of the International Federation of Clinical Neurophysiology*. 2014;125(11):2150-2206.
65. Food and Drug Administration. Brief Summary of the Neurological Devices Panel Meeting – February 10, 2012. 2012; <http://www.fda.gov/downloads/AdvisoryCommittees/CommitteesMeetingMaterials/MedicalDevices/MedicalDevicesAdvisoryCommittee/NeurologicalDevicesPanel/UCM291805.pdf>.
66. Sellers KK, Mellin JM, Lustenberger CM, et al. Transcranial direct current stimulation (tDCS) of frontal cortex decreases performance on the WAIS-IV intelligence test. *Behav Brain Res*. 2015;290:32-44.
67. Slavin KV. Spinal stimulation for pain: future applications. *Neurotherapeutics*. 2014;11(3):535-542.
68. American College of Occupational and Environmental Medicine. *Chronic pain treatment guidelines*. 3rd ed. Westminster, CO.: Reed Group; 2017.
69. Colorado Division of Workers' Compensation. Rule 17, Exhibit 9: Chronic Pain Disorder Medical Treatment Guidelines. 2012; https://www.colorado.gov/pacific/sites/default/files/Rule_17_Exhibit_9_Chronic_Pain_Disorder.pdf Accessed April 4, 2017.
70. Turner JA, Loeser JD, Bell KG. Spinal cord stimulation for chronic low back pain: a systematic literature synthesis. *Neurosurgery*. 1995;37(6):1088-1095; discussion 1095-1086.
71. Dworkin RH, Turk DC, Farrar JT, et al. Core outcome measures for chronic pain clinical trials: IMMPACT recommendations. *Pain*. 2005;113(1-2):9-19.
72. Carragee EJ, Alamin TF, Miller JL, Carragee JM. Discographic, MRI and psychosocial determinants of low back pain disability and remission: a prospective study in subjects with benign persistent back pain. *Spine J*. 2005;5(1):24-35.
73. Merskey H, Bogduk N. *Classification of chronic pain*. 2nd ed. Seattle: IASP Press; 1994.
74. Celestin J, Edwards RR, Jamison RN. Pretreatment psychosocial variables as predictors of outcomes following lumbar surgery and spinal cord stimulation: a systematic review and literature synthesis. *Pain medicine*. 2009;10(4):639-653.

75. den Boer JJ, Oostendorp RA, Beems T, Munneke M, Oerlemans M, Evers AW. A systematic review of bio-psychosocial risk factors for an unfavourable outcome after lumbar disc surgery. *Eur Spine J*. 2006;15(5):527-536.
76. Bruns D, Disorbio JM. Assessment of biopsychosocial risk factors for medical treatment: a collaborative approach. *J Clin Psychol Med Settings*. 2009;16(2):127-147.
77. Bruns D, Disorbio JM. The Psychological Assessment of Patients with Chronic Pain. In: Deer TR, ed. *Comprehensive Treatment of Chronic Pain: Medical, Interventional, and Behavioral Approaches*. New York: Springer; 2013:805-826.
78. Bruns D. Clinical and forensic standards for the psychological assessment of patients with chronic pain. *Psychological Injury and Law*. 2014;7(4):297-316.
79. den Boer JJ, Oostendorp RA, Beems T, Munneke M, Evers AW. Continued disability and pain after lumbar disc surgery: the role of cognitive-behavioral factors. *Pain*. 2006;123(1-2):45-52.
80. Sylvester RK, Lindsay SM, Schauer C. The conversion challenge: from intrathecal to oral morphine. *Am J Hosp Palliat Care*. 2004;21(2):143-147.
81. Popping DM, Elia N, Marret E, Wenk M, Tramer MR. Opioids added to local anesthetics for single-shot intrathecal anesthesia in patients undergoing minor surgery: a meta-analysis of randomized trials. *Pain*. 2012;153(4):784-793.
82. Coffey RJ, Owens ML, Broste SK, et al. Medical practice perspective: identification and mitigation of risk factors for mortality associated with intrathecal opioids for non-cancer pain. *Pain Med*. 2010;11(7):1001-1009.
83. Ruan X, Couch JP, Liu H, Shah RV, Wang F, Chiravuri S. Respiratory failure following delayed intrathecal morphine pump refill: a valuable, but costly lesson. *Pain Physician*. 2010;13(4):337-341.
84. Staats P. Complications of Intrathecal Therapy. *Pain Medicine*. 2008;9(Issue suppl_1, 1 May 2008):S102–S107. <https://doi.org/110.1111/j.1526-4637.2008.00445.x>.
85. Kratzsch T, Stienen MN, Reck T, Hildebrandt G, Hoederath P. Catheter-tip Granulomas Associated with Intrathecal Drug Delivery--A Two-Center Experience Identifying 13 Cases. *Pain Physician*. 2015;18(5):E831-840.
86. Duarte RV, Raphael JH, Southall JL, Baker C, Ashford RL. Intrathecal granuloma formation as result of opioid delivery: systematic literature review of case reports and analysis against a control group. *Clin Neurol Neurosurg*. 2012;114(6):577-584.
87. Aprili D, Bandschapp O, Rochlitz C, Urwyler A, Ruppen W. Serious complications associated with external intrathecal catheters used in cancer pain patients: a systematic review and meta-analysis. *Anesthesiology*. 2009;111(6):1346-1355.
88. Patel VB, Manchikanti L, Singh V, Schultz DM, Hayek SM, Smith HS. Systematic Review of Intrathecal Infusion Systems for Long-Term Management of Chronic Non-Cancer Pain. *Pain Physician*. 2009;12(2):345-360.
89. Deer TR, Pope JE, Hayek SM, et al. The Polyanalgesic Consensus Conference (PACC): Recommendations for Intrathecal Drug Delivery: Guidance for Improving Safety and Mitigating Risks. *Neuromodulation*. 2017;20(2):155-176.
90. Engel GL. The need for a new medical model: a challenge for biomedicine. *Science*. 1977;196(4286):129-136.

91. American College of Occupational and Environmental Medicine. *Chronic pain treatment guidelines*. 2nd ed. Beverly Farms, Mass.: OEM Press; 2008.
92. Colorado Division of Workers' Compensation. Rule 17, Exhibit 7: Chronic Regional Pain Syndrome Medical Treatment Guidelines. 2012;
<http://www.healthpsych.com/tools/crps.pdf>. Accessed April 4, 2017.
93. Work Loss Data Institute. *Official Disability Guidelines*. Encinitas, CA: Work Loss Data Institute; 2016.
94. Centers for Medicare and Medicaid Services. Spinal Cord Stimulators for Chronic Pain (L35136). 2017;
<https://med.noridianmedicare.com/documents/10546/6990981/Spinal+Cord+Stimulators+for+Chronic+Pain+LCD>. Accessed April 20, 2017.
95. BlueCross BlueShield. Spinal Cord Stimulation. 2016;
http://www.bcbsnc.com/assets/services/public/pdfs/medicalpolicy/spinal_cord_stimulation.pdf. Accessed April 20, 2017.
96. Cigna. Cigna Medical Coverage Policies – Musculoskeletal Spinal Cord and Implanted Peripheral Nerve Stimulation. 2016;
http://www.medsolutions.com/cignaguidelines/guideline_downloads/eviCore%20Final%20CMM-211%20Spinal%20Cord%20and%20Implantable%20Peripheral%20Nerve%20Stimulators.pdf. Accessed October 17, 2017.
97. United Healthcare. Electrical Nerve Stimulators. 2017;
https://www.unitedhealthcareonline.com/ccmcontent/ProviderII/UHC/en-US/Main%20Menu/Tools%20&%20Resources/Policies%20and%20Protocols/Medicare%20Advantage%20Policy%20Guidelines/Electrical_Nerve_Stimulators.pdf. Accessed April 20, 2017.
98. California Division of Workers' Compensation. Medical treatment utilization schedule. 2009; https://www.dir.ca.gov/dwc/MTUS/MTUS_RegulationsGuidelines.html. Accessed October 15, 2013.
99. State of Connecticut Worker Compensation Commission. Medical protocols. 2017;
<https://wcc.state.ct.us/download/acrobat/protocols.pdf>. Accessed July 8, 2018.
100. Delaware Department of Labor. Health Care Practice Guidelines: PART B Chronic Pain Treatment Guidelines. 2008;
<http://regulations.delaware.gov/AdminCode/title19/1000/1300/1340/PART%20B%20Chronic%20Pain.shtml>. Accessed April 29, 2017.
101. Louisiana Workforce Commission: Office of Workers' Compensation. Pain medical treatment guidelines. 2010;
http://www.laworks.net/Downloads/OWC/MedicalGuidelines_Pain.pdf. Accessed April 10, 2017.
102. Minnesota Legislature. Minnesota Administrative Rules. 5221.6200 low back pain. 2015;
<https://www.revisor.mn.gov/rules?id=5221&version=2014-09-11T11:12:32-05:00&view=chapter#rule.5221.6200>.
103. State of Mississippi Workers' Compensation Commission. Title 20: Labor. Part 2: Mississippi workers' compensation medical fee schedule. 2016;
<http://www.sos.ms.gov/ACProposed/00019998b.pdf>.

104. Montana Department of Labor and Industry. Montana Utilization and Treatment Guidelines. 2016; <http://www.mtguidelines.com> Accessed March 15, 2017.
105. New York Worker's Compensation Board. New York Non-Acute Pain Medical Treatment Guidelines. 2014; <http://www.wcb.ny.gov/content/main/hcpp/MedicalTreatmentGuidelines/Non-AcutePainMTG2014.pdf>. Accessed April 22, 2017.
106. Oklahoma Physician Advisory Committee. Oklahoma Guidelines for Treatment of Chronic Pain Disorders *Adopted by the Administrator of the Oklahoma Workers' Compensation Court* 2007; <http://www.owcc.state.ok.us/PDF/Guidelines%20for%20Treatment%20of%20Chronic%20Pain%20Disorders.pdf>. Accessed June 10, 2009.
107. State of Rhode Island workers' compensation court medical advisory board. Protocols. 2012; <https://www.courts.ri.gov/Courts/workerscompensationcourt/MedicalAdvisoryBoard/Pages/Protocols.aspx>.
108. West Virginia Workers' Compensation Board of Managers. Title 85: Exempt legislative rule workers' compensation commission. Series 20: Medical management of claims, guidelines for impairment evaluations, evidence, and ratings, and ranges of permanent partial disability awards 2006; [www.wvinsurance.gov/Portals/0/doc/pol leg/rules/wc/c-wc-rule-20.doc](http://www.wvinsurance.gov/Portals/0/doc/pol_leg/rules/wc/c-wc-rule-20.doc).
109. Gybels J, Erdine S, Maeyaert J, et al. Neuromodulation of pain. A consensus statement prepared in Brussels 16-18 January 1998 by the following task force of the European Federation of IASP Chapters (EFIC). *Eur J Pain*. 1998;2(3):203-209.
110. Beltrutti D, Lamberto A, Barolat G, et al. The psychological assessment of candidates for spinal cord stimulation for chronic pain management. *Pain Practice*. 2004;4(3):204-221.
111. Disorbio JM, Bruns D, Barolat G. Assessment and treatment of chronic pain: A physician's guide to a biopsychosocial approach. *Practical Pain Management* 2006; http://www.healthpsych.com/articles/biopsychosocial_tx.pdf. Accessed 6/28/2010.
112. Bruns D, Disorbio JM. Chronic pain and biopsychosocial disorders. *Practical Pain Management* 2005; <http://www.healthpsych.com/articles/biopsychosocial.pdf>. Accessed 6/28/2010.
113. Brox JI, Sorensen R, Friis A, et al. Randomized clinical trial of lumbar instrumented fusion and cognitive intervention and exercises in patients with chronic low back pain and disc degeneration. *Spine (Phila Pa 1976)*. 2003;28(17):1913-1921.
114. Brox JI, Nygaard OP, Holm I, Keller A, Ingebrigtsen T, Reikeras O. Four-year follow-up of surgical versus non-surgical therapy for chronic low back pain. *Ann Rheum Dis*. 2010;69(9):1643-1648.
115. Keller A, Brox JI, Reikeras O. Predictors of change in trunk muscle strength for patients with chronic low back pain randomized to lumbar fusion or cognitive intervention and exercises. *Pain Med*. 2008;9(6):680-687.
116. Mannion AF, Brox JI, Fairbank JC. Consensus at last! Long-term results of all randomized controlled trials show that fusion is no better than non-operative care in improving pain and disability in chronic low back pain. *Spine J*. 2016;16(5):588-590.

117. O'Keeffe M, Purtill H, Kennedy N, et al. Comparative effectiveness of conservative interventions for non-specific chronic spinal pain: Physical, behavioural/psychologically informed or combined? A systematic review and meta-analysis. *J Pain*. 2016.
118. Bruns D, Mueller K, Warren PA. Biopsychosocial law, health care reform, and the control of medical inflation in Colorado. *Rehabilitation psychology*. 2012;57(2):81-97.
119. Meyer GJ, Finn SE, Eyde LD, et al. Psychological testing and psychological assessment. A review of evidence and issues. *Am Psychol*. 2001;56(2):128-165.
120. Fishbain DA, Bruns D, Disorbio JM, Lewis JE. Risk for five forms of suicidality in acute pain patients and chronic pain patients vs pain-free community controls. *Pain Med*. 2009;10(6):1095-1105.
121. Fishbain DA, Lewis JE, Bruns D, Gao J, Disorbio JM, Meyer L. Patient predictor variables for six forms of suicidality. *Eur J Pain*. 2012;16(5):706-717.
122. Fishbain DA, Bruns D, Meyer LJ, Lewis JE, Gao J, Disorbio JM. Exploration of the relationship between disability perception, preference for death over disability, and suicidality in patients with acute and chronic pain. *Pain Med*. 2012;13(4):552-561.
123. Fishbain DA, Bruns D, Bruns A, et al. The Perception of Being a Burden in Acute and Chronic Pain Patients Is Associated with Affirmation of Different Types of Suicidality. *Pain Med*. 2016;17(3):530-538.
124. Bruns D, Disorbio JM. Hostility and violent ideation: physical rehabilitation patient and community samples. *Pain Med*. 2000;1(2):131-139.
125. Fishbain DA, Bruns D, Disorbio JM, Lewis JE. Correlates of self-reported violent ideation against physicians in acute--and chronic-pain patients. *Pain Med*. 2009;10(3):573-585.
126. Bruns D, Disorbio JM, Hanks R. Chronic pain and violent ideation: testing a model of patient violence. *Pain Med*. 2007;8(3):207-215.
127. Bruns D, Disorbio JM, Hanks R. Chronic nonmalignant pain and violent behavior. *Curr Pain Headache Rep*. 2003;7(2):127-132.
128. Fishbain DA, Bruns D, Lewis JE, Disorbio JM, Gao J, Meyer LJ. Predictors of homicide-suicide affirmation in acute and chronic pain patients. *Pain Med*. 2011;12(1):127-137.
129. Bruns D, Fishbain DA, Disorbio JM, Lewis JE. What variables are associated with an expressed wish to kill a doctor in community and injured patient samples? *J Clin Psychol Med Settings*. 2010;17(2):87-97.
130. Fishbain DA, Bruns D, Disorbio JM, Lewis JE. What patient attributes are associated with thoughts of suing a physician? *Arch Phys Med Rehabil*. 2007;88(5):589-596.
131. Fishbain DA, Bruns D, Disorbio JM, Lewis JE. What are the variables that are associated with the patient's wish to sue his physician in patients with acute and chronic pain? *Pain Med*. 2008;9(8):1130-1142.
132. Fishbain DA, Gao J, Lewis JE, Bruns D, Meyer LJ, Disorbio JM. Prevalence comparisons of somatic and psychiatric symptoms between community nonpatients without pain, acute pain patients, and chronic pain patients. *Pain Med*. 2015;16(1):37-50.
133. Fishbain D, Gao JR, Lewis J, Bruns D, Meyer LJ, Disorbio JM. Examination of symptom clusters in acute and chronic pain patients. *Pain Physician*. 2014;17(3):E349-357.
134. Tragesser SL, Bruns D, Disorbio JM. Borderline personality disorder features and pain: the mediating role of negative affect in a pain patient sample. *Clin J Pain*. 2010;26(4):348-353.

135. Fishbain DA, Bruns D, Meyer LJ, Lewis JE, Gao J, Disorbio JM. Exploring the Relationship of Three Medical Entitlement Beliefs and Psychiatric/Psychological Variables for Acute and Chronic Pain Patients. *Pain Pract.* 2015;15(6):518-529.
136. Fishbain DA, Bruns D, Meyer LJ, Lewis JE, Gao J, Disorbio JM. Exploration of affirmation of childhood molestation (sexual abuse) in chronic pain patients, acute pain patients, community patients with pain and community nonpatients without pain. *Pain Pract.* 2014;14(6):515-525.
137. Sullivan MJ, Thorn B, Haythornthwaite JA, et al. Theoretical perspectives on the relation between catastrophizing and pain. *Clin J Pain.* 2001;17(1):52-64.
138. Bruns D, Disorbio JM. The psychological assessment of patients with chronic pain. In: Deer TR, Leong MS, Ray AL, eds. *Treatment of chronic pain by integrative approaches : the American Academy of Pain Medicine textbook on patient management.* New York ; Heidelberg ; Dordrecht ; London: Springer; 2015:xix, 325 pages.
139. Bruns D, Disorbio JM. The Psychological Evaluation of Patients with Chronic Pain: a Review of BHI 2 Clinical and Forensic Interpretive Considerations. *Psychol Inj Law.* 2014;7(4):335-361.
140. Bruns D, Disorbio JM. Chronic pain and biopsychosocial disorders. *Practical Pain Management.* 2005;5(7):52-61.
141. Millon T, Antoni M, Millon C, Minor S, Grossman S. *Millon Behavioral Medicine Diagnostic manual supplement: Pain patient reports.* Minneapolis: Pearson Assessments; 2010.
142. Bruns D, Disorbio JM. *Battery for Health Improvement 2 Manual.* Minneapolis: Pearson; 2003.
143. Disorbio JM, Bruns D, Barolat G. Assessment and treatment of chronic pain: A physician's guide to a biopsychosocial approach. *Practical Pain Management.* 2006;6(2):11-27.
144. Bruns D. Psychological Tests Commonly Used in the Assessment of Chronic Pain. In: Colorado Department of Labor and Employment: Division of Worker Compensation; 2015:1-33.
145. Tsui JI, Anderson BJ, Strong DR, Stein MD. Craving predicts opioid use in opioid-dependent patients initiating buprenorphine treatment: a longitudinal study. *Am J Drug Alcohol Abuse.* 2014;40(2):163-169.
146. American Psychological Association. *APA Dictionary of Clinical Psychology.* Washington, DC: American Psychological Association; 2012.
147. Kori SH, Miller RP, Todd DD. Kinesiophobia: a new view of chronic pain behavior. *Pain management.* 1990;3(1):35-43.
148. Wertli MM, Rasmussen-Barr E, Held U, Weiser S, Bachmann LM, Brunner F. Fear-avoidance beliefs-a moderator of treatment efficacy in patients with low back pain: a systematic review. *Spine J.* 2014.
149. Wertli MM, Rasmussen-Barr E, Weiser S, Bachmann LM, Brunner F. The role of fear avoidance beliefs as a prognostic factor for outcome in patients with nonspecific low back pain: a systematic review. *Spine J.* 2014;14(5):816-836 e814.
150. Hudes K. The Tampa Scale of Kinesiophobia and neck pain, disability and range of motion: a narrative review of the literature. *J Can Chiropr Assoc.* 2011;55(3):222-232.

151. Bruns D, Disorbio JM. Spinal cord stimulation and related electrical treatments: A primer and glossary of terms from the biopsychosocial perspective. 2017; v1.1:http://bit.ly/scs_glossary. Accessed July 22, 2017.
152. Millon T, Antoni M, Millon C, Meagher S, Grossman S. *Millon Behavioral Medicine Diagnostic Manual*. Minneapolis: Pearson Assessments; 2001.
153. Bruns D, Bruns A, Disorbio JM. Predicting Subtle Fake Good Status In Patients Being Treated For Chronic Pain. American Psychological Association National Convention; 2015; Toronto.
154. Bruns D, Bruns A, Disorbio JM. Predicting Subtle Fake Bad Status In Patients Being Treated For Chronic Pain. American Psychological Association National Convention; 2015; Toronto.
155. Fishbain DA, Lewis JE, Bruns D, Disorbio JM, Gao J, Meyer LJ. Exploration of anger constructs in acute and chronic pain patients vs. community patients. *Pain Pract*. 2011;11(3):240-251.
156. Fishbain DA, Lewis JE, Bruns D, Disorbio JM, Gao J, Meyer LJ. Exploration of Anger Constructs in Acute and Chronic Pain Patients vs. Community Patients. *Pain Pract* 2010; 2010/08/27:http://www.ncbi.nlm.nih.gov/entrez/query.fcgi?cmd=Retrieve&db=PubMed&dopt=Citation&list_uids=20738789.
157. Fishbain DA, Bruns D, Disorbio JM, Lewis JE, Gao J. Variables associated with self-prediction of psychopharmacological treatment adherence in acute and chronic pain patients. *Pain Pract*. 2010;10(6):508-519.
158. Fishbain DA, Bruns D, Disorbio JM, Lewis JE, Gao J. Exploration of the illness uncertainty concept in acute and chronic pain patients vs community patients. *Pain Med*. 2010;11(5):658-669.
159. Block AR, Gatchel RJ, Deardorff WW, Guyer RD. *The psychology of spine surgery*. Washington DC: American Psychological Association; 2003.
160. Datz G, Bruns D. Billing and Coding for Psychological Pain Management. In: Deer TR, ed. *Comprehensive Treatment of Chronic Pain: Medical, Interventional, and Behavioral Approaches*. New York: Springer; 2013.
161. Bruns D, Kessler R, Van Dorsten B. The Practice of Psychology in Medical Settings: Financially Sustainable Models. In: Hunter C, Hunter C, Kessler R, eds. *Handbook of Clinical Psychology in Medical Settings: Evidence Based Assessment and Intervention*. New York: Springer; 2014:199-216.
162. Linehan M. *DBT skills training manual*. Second edition. ed. New York: The Guilford Press; 2015.